



710 Series ECU

Hardware Manual

OMEM710

1 Introduction..... 6

1.1 Notation Used in This Manual 6

2 Setup Procedure..... 7

3 Software 9

4 Inputs and Outputs..... 10

4.1 Ignition Coils..... 10

4.2 Fuel Injector..... 10

4.3 PWM Devices..... 10

4.4 Switch Outputs 11

4.5 Switch inputs 12

5 Sensor Setup 13

5.1 Throttle Position Sensor 13

5.2 MAP Sensor 13

5.3 MAF Sensor 14

5.4 Coolant Temperature Sensor 14

5.5 Air Temperature sensor..... 15

5.6 Barometric Pressure..... 16

5.7 Road Speed Sensor 16

5.8 Crank Sensor 17

5.9 Trigger Wheel..... 18

5.10 Cam1 Sensor 20

5.11 Cam2 Sensor 21

5.12 Ignition Timing Alignment 21

6 Map Axes..... 23

6.1 Engine Speed..... 23

6.2 Engine Load 23

7 Basic Fuel Setup 26

7.1 Battery Voltage Compensation..... 27

8 Rev Limits 30

9 Dashboard..... 31

9.1 Tacho 31

9.2 Shift Light 31

9.3 Gear dependent shift light speed 31

10 Engine Start Condition..... 32

10.1 Ignition 32

10.2 Fuel 32

11 Idle Strategies 34

11.1 Without air bypass idle motor 34

11.2 With air bypass idle motor 35

12 Transient Conditions..... 39

12.1 Acceleration Fuel 39

12.2 Deceleration Fuel Cut Off..... 41

13 Conditions Corrections..... 42

13.1 Coolant Temperature 42

13.2 Air Temperature 42

13.3 Barometric Pressure 43

13.4 Individual Fuel Output Trims 43

14 Cold Engine Running..... 44

15 Oxygen Feedback..... 45

15.1 Narrowband 45

15.2 Wideband..... 48

16	Cooling Fans	49
17	Knock Control	50
18	Full Throttle Gearshift	51
19	Staged Injectors	54
19.1	Twin Injectors	54
19.2	Staged Injectors	54
20	VTEC Cam Control	55
21	VVC Cam Control	56
22	Turbo Boost Control	57
23	Anti-lag	58
24	Alt Function	59
25	User1	60
26	Internal Data Logging	61
27	Ignition Dwell Control	62
28	Security	63
29	Wiring	65
29.1	Semi Assembled Loom Construction	65
29.2	ECU Connector Pins	66
29.3	Component Pin-outs	67
29.4	Diagrams	68

1 Introduction

Thank you for choosing Omex Engine Management. This manual is written to help the user through the specifics of the OMEM710 ECU. **It is essential that the user reads all of the Omex manuals before attempting to install the system and before attempting to start the engine.** Incorrect use of the Omex system could potentially lead to damage to the engine and personal injury. If you have any doubts about fitting these parts or using the software then please contact Omex for help.

As the system is computer based, technical support is given on the assumption that the user is able to perform simple Windows based operations. The user will also need access to email as Omex will nearly always require a copy of the map in the ECU to give support.

Omex may not be held responsible for damage caused through following these instructions, technical, or editorial errors or omissions. If you have any doubts about fitting these parts or using the software then please contact Omex for help.

1.1 Notation Used in This Manual

Menu commands are signified in bold type with a pipe symbol | between each level of the menu.

For example, **File | Open** indicates that you should click on the **Open** option in the **File** menu.

UPPER CASE TEXT is used to indicate text that should be typed in by the user.

2 Setup Procedure

Wiring

Wire your semi-assembled harness or ready-built harness as shown in the Wiring section of this manual.

Trigger Wheel

If installing a trigger wheel of missing tooth type,

- Accurately mark TDC.
- Turn the engine to approximately 90° BTDC.
- Mount your crank position sensor (CPS) anywhere around the perimeter of the timing wheel pointing towards the centre of the wheel with a sensor to wheel gap of approximately 0.5mm.
- Mount the trigger wheel with the missing tooth pointing at the sensor.

If machining a trigger pattern into the front pulley then it is usually easiest to machine all of the teeth in, mount the front pulley, and then remove the tooth pointing at the sensor at 90° BTDC.

Software

Follow the 'Software' chapter of this manual for instructions on how to connect to your ECU and send your startup calibration.

Setup before mapping

Follow the 'Auxiliary Inputs and Outputs' chapter, though we suggest that all non-essential functions (e.g. full throttle gearshift) are disabled until fuel and ignition mapping is complete.

Follow the 'Sensor Setup' chapter.

Follow the 'Rev Limits' chapter.

Follow the 'Map Axes' chapter (advanced users only).

For many engine configurations, the majority of these sections can be ignored as the start-up calibration will be set to suit the standard engine. Refer to the calibration's notes field for information about sensors used in the calibration.

First start fuel

When attempting to start the engine for the first time you may need to change the injector scaling as the fuel requirements, injector flowrates, and fuel pressure vary between engines. The option **Microsec/bit** is a linear scaling factor. A higher number is more fuel, a lower number is less.

First start ignition timing

Follow the 'Ignition Timing Alignment' section of the 'Sensor Setup' chapter.

Main fuel and ignition mapping

Ensure before mapping that the oxygen feedback is disabled by setting **Standard | OX FB | OX FB Rate** = 0.

If a road car, calibrate the injector battery voltage offsets before much mapping is done.

Map all fuel and ignition in steady state conditions.

Calibrate warm running transient fuel.

Calibrate warm engine starting fuel.

Cold starting / running setup

It is important to calibrate the cold running in the correct order as some of the tables are in effect all of the time and so will affect the results of others.

Start engine from cold however you can (ignoring the cold cranking fuel for now), and calibrate the **Coolant Fuel trim table** and the **Accel Coolant trim table**. The **Coolant fuel trim table** is used for steady-state engine running, and the **Accel Coolant trim table** for increased acceleration fuel whilst cold. Refer to the relevant sections for further advice on this.

When the cold running is complete, you can calibrate cold starting. Refer to the relevant section for advice on this.

3 Software

Installing the software

Run **SetupMAP4000.x.xx.xx.exe** and follow the onscreen instructions.

Connection port

The ECU requires an RS232 serial connection. Desktop PCs and older laptops will have 9pin D shaped ports on them marked COM for this type of communication. If you have this port then this is the best to use for communication with the ECU. If your PC does not have one of these ports then you will need to use an adapter. We suggest using the USB to RS232 adapter from 'ATEN' as the software has been specifically designed for this adapter.

Connecting to the ECU

- Ensure that if you are using an adapter, the drivers software from the adapter manufacturer has been installed.
- Join the data lead between the ECU and the PC
- Open MAP4000 from the 'Start bar'
- Go to **ECU | Connection Setup** and select your port from the list
- **ECU | Connect**
- Ignition ON (do not crank the engine)
- The 'Receiving Calibration' bar will start moving across. When completed, you are connected to the ECU.

Sending the startup calibration to the ECU

It is not possible to start a new calibration from File | New. Please contact Omex for a suitable start-up calibration.

- Save the start-up calibration from the start-up disk or email to the hard-drive in the location Documents\OMEX\MAP4000\Calibrations. (note that this folder is only created when MAP4000 is opened for the first time so you must have opened MAP4000 on this PC before)
- Connect to the ECU as described in the above section.
- **ECU | Send new calibration**
- Ignition ON (do not crank the engine)
- Select your start-up calibration and press 'open'
- When the calibration has been sent to the ECU cycle ignition power OFF / ON

4 Inputs and Outputs

The physical input and output pins for each function are in some cases fixed (eg Coolant Temperature sensor must always be on the same physical pin) but many are selectable. The physical pins have names based on their normal output type, but the names do not necessarily tell the user what they are being used as. The wiring section of the manual gives suggested pin-outs for most engines but some will need to be decided by the user. If you are in any doubt then please contact Omex. The ECU needs to be told which pins are being used for which functions. Much of this will be set in startup calibrations from Omex.

4.1 Ignition Coils

Ignition coils may be controlled on any of the IGN pins. To set an IGN pin as a coil driver it must have the **IGNx** and **TOCx** ON.

IGN/FUEL selection	
IGN1	ON
TOC1	ON

4.2 Fuel Injector

Injectors may be controlled by any of the FUEL pins and IGN3, IGN4, IGN5, or IGN6.

To set a FUEL pin as an injector driver it must have the **FUELx as injector** ON and **FUELx as PWM** OFF.

FUEL/PWM selection	
FUEL1 as Injector	ON
FUEL1 as PWM1	OFF

To set IGN3, IGN4, IGN5, or IGN6 pin as an injector driver they must have the **TOCx** and **IGNx as FUELx** ON. **IGNx** must be OFF.

IGN/FUEL selection	
IGN3	OFF
TOC3	ON
IGN3 used as FUEL9	ON
FUEL9 as Injector	ON

4.3 PWM Devices

PWM devices (such as idle motors, boost solenoids etc) may be controlled by any of the FUEL pins. To set a FUEL pin as a PWM driver it must have the **FUELx as PWMx** ON and **FUELx as injector** OFF.

FUEL/PWM selection	
FUEL1 as Injector	OFF
FUEL1 as PWM1	ON

Controls are then applied to these activated PWM outputs using the **Setup | Output Pin Allocation | PWM Outputs** options group.

PWM Outputs	
Idle PWM1 out	None
Idle PWM2 out	None
WG Single Out	None
WG Twin Out	None
User1 PWM Out	None
VVC1 PWM Out	None
VVC2 PWM Out	None

The PWM outputs will usually require inverting.

PWM Inverts	
PWM1 invert	ON

4.4 Switch Outputs

Switch outputs may be controlled by IGN pins, FUEL pins, or HIGHSIDE pins.

To set an IGN pin as a switch output it must have both the **IGNx** and **TOCx** OFF.

IGN/FUEL selection	
IGN1	OFF
TOC1	OFF

To set a FUEL pin as a switch output it must have both the **FUELx** and **PWMx** OFF.

FUEL/PWM selection	
FUEL1 as Injector	OFF
FUEL1 as PWM1	OFF

The HIGHSIDE pins are switch pins only so do not need the hardware switching to this output type.

Controls are then applied to these switch outputs using the **Switch Outputs** drop-down options group.

Switch Outputs	
Fuel Pump Out	Disable
Rad Fan Out	Disable
Bay Fan Out	Disable
A/C Out	Disable
ALS Out	Disable
VTEC Out	Disable
Alt Out	Disable
Main Relay Out	Disable
Shiftlight Out	Disable
Idle1 Stepper Out	Disable
Idle2 Stepper Out	Disable
Idle3 Stepper Out	Disable
Idle4 Stepper Out	Disable

If the output needs to work in reverse (ie the output going OFF when the software function goes ON) then use the **inverted** option version.

There are also options of N.U., tacho and tele. Do not use these unless instructed to do so by Omex.

4.5 Switch inputs

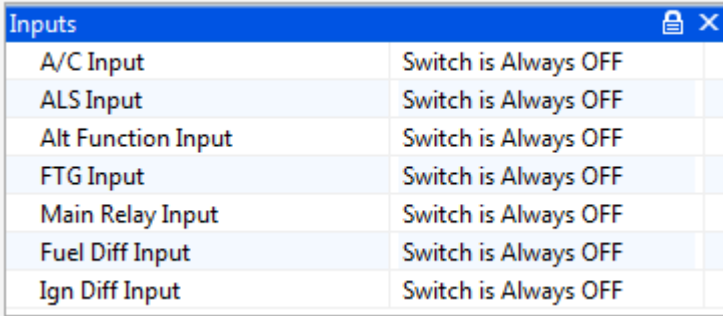

Inputs	
A/C Input	Switch is Always OFF
ALS Input	Switch is Always OFF
Alt Function Input	Switch is Always OFF
FTG Input	Switch is Always OFF
Main Relay Input	Switch is Always OFF
Fuel Diff Input	Switch is Always OFF
Ign Diff Input	Switch is Always OFF

Switch input pins are selected using the drop-down options. A switch input function can have any of the input pins on the list assigned to it so long as they are not being used already by sensors. (eg. If an oxygen sensor is being used on pin OX1, a switch clearly cannot be assigned to this pin). For a function to be active always without a physical switch to turn it on (sometimes this is the case with the Alt Function) select **Switch is Always ON**.

5 Sensor Setup

5.1 Throttle Position Sensor

Throttle Position Sensor		
TPS min	20	
TPS max	220	
TPS AutoZero Gain	1	
TPS AutoZero Offset	0.508	Volts

The parameter **TPS raw** gives the raw number output of the sensor which is scaled by options **TPS min** and **TPS max** to give a throttle that works between 0 and 100%. To calibrate;

- A live reading is shown for **TPS raw**. **TPS raw** will be between 0 and 255. The throttle position sensor can often be rotated by the user. If so, the position should be set so that the sensor never reaches 0 or 255 during its closed throttle to open throttle movement. It is preferable to have the sensor set so that the values do not go close to either extreme. Typically a value of approximately 20 at the idle position will give an acceptable value at WOT (wide open throttle).
- The number for **TPS raw** at WOT needs to have 1 added to it, then be inputted to the options box as **TPS max** (i.e. if TPS Raw is 220, then input 221). The number for **TPS raw** at the idle position needs inputting to the options box as **TPS min**.

The Autozero options allow the ECU to automatically re-learn the idle position of the throttle sensor every time the ECU is turned on. 0 disables this feature.

5.2 MAP Sensor

MAP Sensor		
MAP for Load	OFF	
Load Scalar	1.0000	
Load Offset	0.0000	
MAP Cal	12	Teeth
MAP min	0	
MAP max	255	

If you are using MAP for engine load sensing then set **MAP for Load ON**.

MAP min and **MAP max** should be **0** and **255**. Do not change these unless instructed to by Omex.

MAP Cal is the the time over which the ECU averages the MAP sensor input. Measured in internal units. Typically 12.

As standard, the fuel map and ignition map will show load values of 0-100KPa. This is not KPa, this is simply 0-100% of the range of the sensor. It is possible to tell the ECU what range the sensor has so that you can read the true KPa value on the maps.

Load Scalar The multiple of 1 that describes the theoretical 0-5V full scale of the sensor.

Load offset Most MAP sensors do not have 0V at 0KPa, they have a slight offset. This option describes the offset.

Omex have the values for the sensors sold by Omex. If you want to calibrate your own sensor then either find the voltage output information (total scale, and offset) from the manufacturer, or follow this procedure;

- Select a suitable start point for **Load Scalar** to suit your sensor e.g. for a nominally 2bar sensor, enter **2**
- Note the current value for **MAP as Load**
- Change the pressure at the sensor by a known amount using a vacuum pump
- Ignoring the absolute value, adjust **Load Scalar** until the correct change in value is shown by **MAP as Load** to suit that pressure change e.g. if you have reduced the pressure by 50kPa, then adjust **Load Scalar** until **MAP as Load** shows 50kPa less than it did before the pressure change was made
- Remove the pressure change and try the above again. As this is an iterative procedure you may need to do it several times before the correct change is shown on the ECU

Remove any pressure changes from the sensor and adjust **Load offset** until **MAP as Load** shows the current barometric air pressure.

5.3 MAF Sensor

Contact Omex if you would like to use MAF as the load sensor.

5.4 Coolant Temperature Sensor

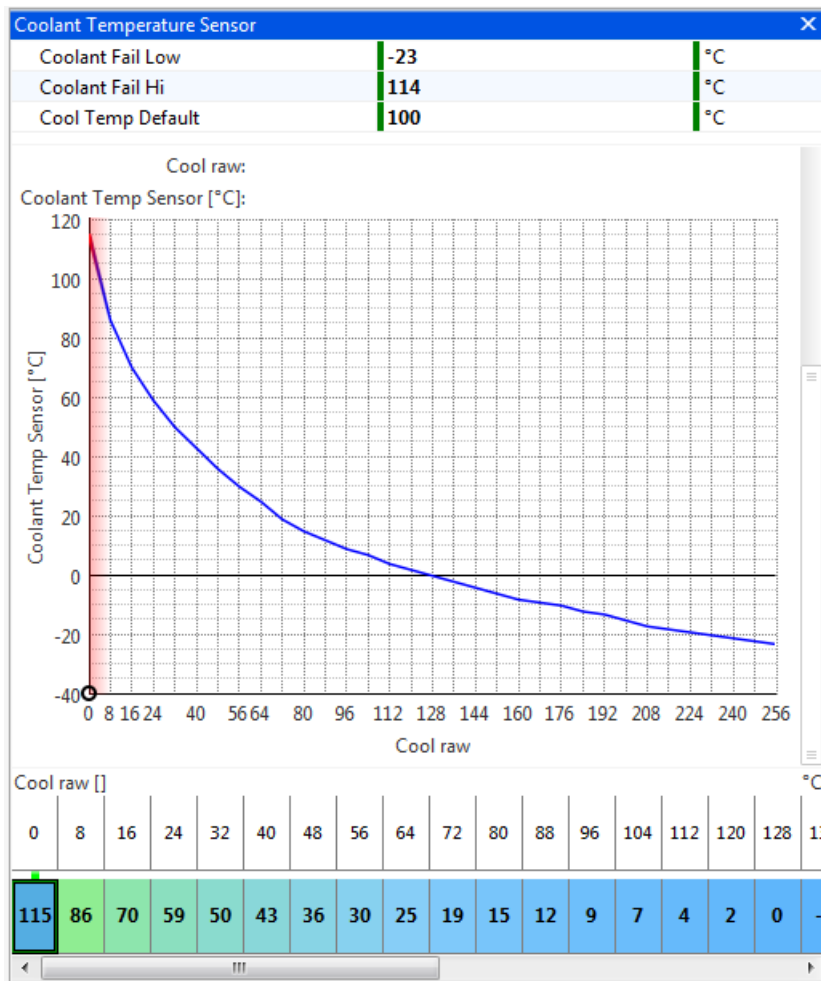

The coolant temperature sensor used by the Omex ECU is a resistive sensor. The raw output of this sensor is calibrated in the ECU to give the information in a more usable form, °C. Sensors are calibrated in the **Coolant Temp Sensor table**. The values for many sensors are known but you may

need to calibrate your sensors. It is essential that these sensors are calibrated correctly as many functions are temperature based.

To calibrate a sensor;

- Place the sensor and a thermometer in a kettle or pan of water
- The ECU will highlight the current raw input value from the sensor along the upper line of the table. Below this input value, enter the current thermometer reading in degrees centigrade.
- Heat the water. As the temperature increases, repeat the temperature readings.
- When the water is fully heated, repeat the process as the water cools
- Using the graph view, smooth the curve to remove any mistakes, and extrapolate to unobtainable temperatures.

Coolant Fail Low and **Hi** are the failure points of the sensor and should be set to just within the reading limits of the sensor.

Example- If the lowest temperature in the sensor table is -25 then **Coolant Fail Low** should be set 1 higher at -24. If the highest temperature in the sensor table is 125 then **Coolant Fail Hi** should be set 1 lower to 124. **Coolant Temp Default** is the temperature to which the input defaults if the sensor goes into failure.

5.5 Air Temperature sensor

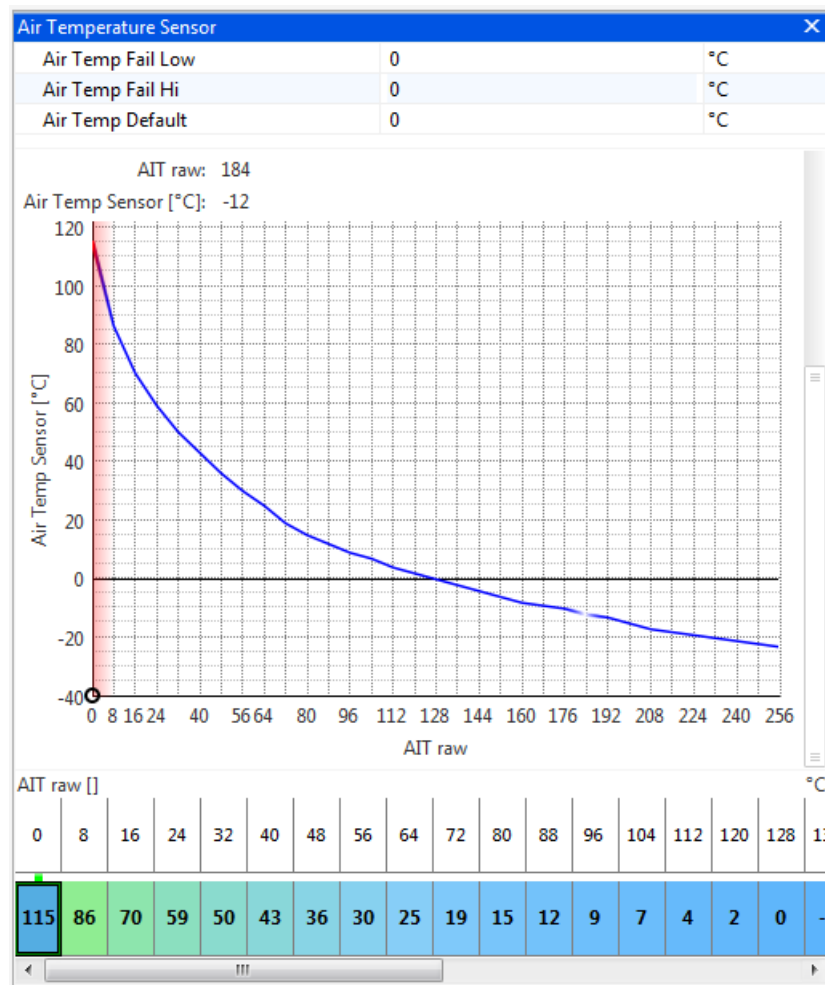

The air temperature sensor used by the Omex ECU is a resistive sensor. The raw output of this sensor is calibrated in the ECU to give the information in a more usable form, °C. Sensors are calibrated in the **Air Temp Sensor table**. The values for many sensors are known but you may need to calibrate your sensors. It is essential that these sensors are calibrated correctly as many functions are temperature based.

To calibrate your sensor, see the calibration of the coolant temperature sensor.

Air Temp Fail Low and **Hi** are the failure points of the sensor and should be set to just within the reading limits of the sensor.

Example- If the lowest temperature in the sensor table is -25 then **Air Temp Fail Low** should be set 1 higher at -24. If the highest temperature in the sensor table is 125 then **Air Temp Fail Hi** should be set 1 lower to 124. **Air Temp Default** is the temperature to which the input defaults if the sensor goes into failure.

5.6 Barometric Pressure

As the air pressure changes, so does the amount of oxygen per volume of air. Changes in most countries are relatively little, but if driving in large mountain ranges, these changes can be significant. The 710 ECU has an in-built 1bar MAP sensor which may be used for barometric correction. As the 710 has an inbuilt sensor, no calibration is required, the function is simply enabled or disabled. **Baro** must NOT be checked if using the internal sensor for load. There is a Baro Source option to allow the use of external baro sensors where required.

Barometric Pressure Sensor	
Baro On	ON
Baro source	Baro Voltage
Baro M	28020
Baro C	2750

5.7 Road Speed Sensor

Road Speed Sensor	
Road Speed M	0.0000
Rd Spd Rising Edge	OFF
Rd Spd Falling Edge	OFF

The road speed sensor is only required if you wish to use gear dependent shift light speeds. The input should be a pre-differential driven wheel input e.g. propshaft rpm.

The road speed sensor can only be calibrated once the engine is running.

The option **Road Speed M** is a scalar and should be adjusted until the parameter **Road Speed** reads the current road speed.

Rd Spd Falling Edge and **Rd Spd Rising Edge** specify the edge of the input waveform from the sensor to use as the significant edge. Typically **Rd Spd Falling Edge**.

Road speed can be displayed as either mph or kph. To adjust the units used go to **Configure | Units/Scaling | Road Speed Units**.

Jumper

To allow for different types of sensor, physical jumpers need to be set. The following diagram shows an aerial view of the ECU board with the main wiring connector on the right-hand side.

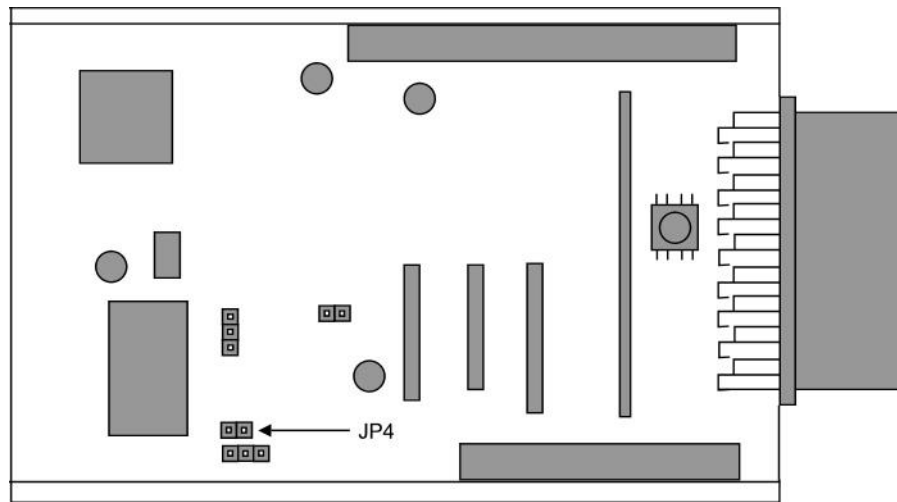

Sensor Type	Jumper Position
Typical MVR	OFF
Hall Effect	ON

5.8 Crank Sensor

The crank sensor input can be from either a Magnetic Variable Reluctance (MVR) sensor or a Hall Effect sensor. The two types of sensor require different software and hardware jumper settings.

MVR

Sensor		
Crank Hi Gain Below	1900	rpm
Crank Lo Gain Above	2000	rpm
Crank Rising Edge	OFF	
Crank Falling Edge	ON	

The crank sensor high and low gain settings allow a user definable change point for high sensitivity to allow for low magnetic crank sensor outputs at low engine speeds. Typically the values are just above idle speed.

Magnetic sensors can use either the rising or falling edge of the generated waveform. If the edge is incorrect then the engine will misfire at some point in the engine speed range. There is also the possibility that if the edge is incorrect on a magnetic sensor of the ignition timing on the engine deviating from the ignition timing calculated by the ECU as the engine speed changes. To find the correct edge either see which edge does / does not produce ignition timing changes, or using an oscilloscope to look at the waveform. If the signal falls through the missing tooth section use **Crank Rising Edge**, and if it rises through the missing tooth section use **Crank Falling Edge**.

Hall Effect

Sensor		
Crank Hi Gain Below	0	rpm
Crank Lo Gain Above	0	rpm
Crank Rising Edge	OFF	
Crank Falling Edge	ON	

Hall effect sensors require values of 0 for the high and low gain settings as their output is the same amplitude regardless of engine speed.

Hall Effect sensors can use either the rising or falling edge, though typically the falling edge would be used.

Jumpers

To allow for different input ranges of the crank sensors, physical jumpers need to be set. The following diagram shows an aerial view of the ECU board with the main wiring connector on the right-hand side.

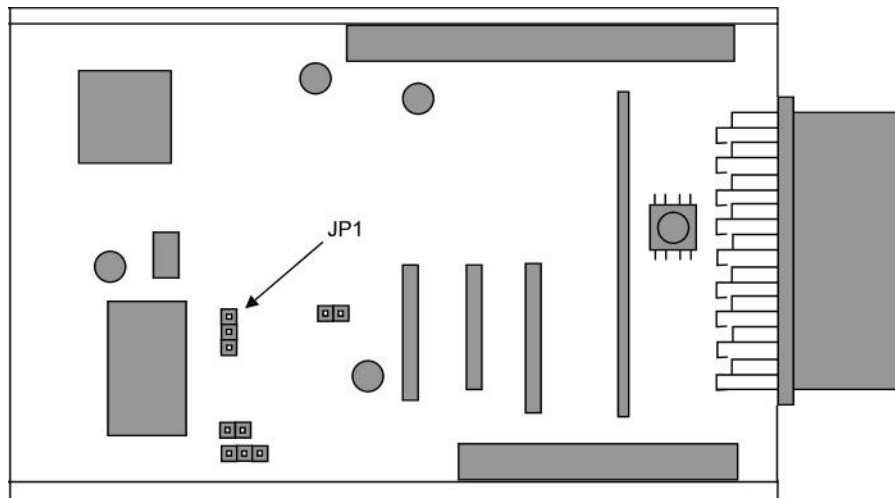

Sensor Type	Jumper Position	
Typical MVR	none	<input type="checkbox"/> <input type="checkbox"/> <input type="checkbox"/>
High Output MVR	1 2	<input checked="" type="checkbox"/> <input type="checkbox"/>
Hall Effect	2 3	<input type="checkbox"/> <input checked="" type="checkbox"/>

5.9 Trigger Wheel

The pattern of teeth on the crank pulley or flywheel that the crank sensor faces is known as a trigger wheel. The pattern is evenly spaced teeth with missing or extra teeth as reference points. As different manufacturers use different trigger patterns, the ECU is programmable to suit. The information required in the ECU for many of the popular patterns is already known, some of which are listed below. If you have a different pattern on your engine please contact Omex for advice.

It is very easy to make an engine run, but not run properly by incorrectly entering these options and tables. If possible please contact Omex for a calibration aspect or email an existing calibration to Omex to be changed to a different trigger pattern.

36-1

Trigger Wheel		
MX Sync Test	34	tooth
Missing	1	teeth
MX Time	50	%
MX Time Start	35	%
Test Not Sync'd	OFF	

Tooth Control table:

0	1	2	3	4	5	6	7	8	9	10	11	12	13	14	15	16	17	18	19
5	4	4	5	4	4	5	4	4	5	4	4	5	4	4	5	4	4	5	4
20	21	22	23	24	25	26	27	28	29	30	31	32	33	34	35	36	37	38	39
4	5	4	4	5	4	4	5	4	4	5	4	4	5	4	3	3	3	3	3
40	41	42	43	44	45	46	47	48	49	50	51	52	53	54	55	56	57	58	59
3	3	3	3	3	3	3	3	3	3	3	3	3	3	3	3	3	3	3	3

60-2

Trigger Wheel		
MX Sync Test	57	tooth
Missing	2	teeth
MX Time	50	%
MX Time Start	35	%
Test Not Sync'd	OFF	

Tooth Control table:

0	1	2	3	4	5	6	7	8	9	10	11	12	13	14	15	16	17	18	19
5	4	4	4	4	5	4	4	4	4	5	4	4	4	4	5	4	4	4	4
20	21	22	23	24	25	26	27	28	29	30	31	32	33	34	35	36	37	38	39
5	4	4	4	4	5	4	4	4	4	5	4	4	4	4	5	4	4	4	4
40	41	42	43	44	45	46	47	48	49	50	51	52	53	54	55	56	57	58	59
5	4	4	4	4	5	4	4	4	4	5	4	4	4	4	5	4	4	3	3

Rover K-Series (late)

Trigger Wheel		
MX Sync Test	2	tooth
Missing	1	teeth
MX Time	30	%
MX Time Start	30	%
Test Not Sync'd	OFF	

Tooth Control table:

0	1	2	3	4	5	6	7	8	9	10	11	12	13	14	15	16	17	18	19
4	4	5	4	4	5	4	4	5	4	4	5	4	5	4	5	4	4	5	4
20	21	22	23	24	25	26	27	28	29	30	31	32	33	34	35	36	37	38	39
4	5	4	4	5	4	4	5	4	5	4	5	3	3	3	3	3	3	3	3
40	41	42	43	44	45	46	47	48	49	50	51	52	53	54	55	56	57	58	59
3	3	3	3	3	3	3	3	3	3	3	3	3	3	3	3	3	3	3	3

5.10 Cam1 Sensor

If an engine is to control the injectors sequentially or ignition coil-per-plug, it needs information about what part of the engine cycle it is in (there are two crank revolutions per engine cycle for a 4 stroke engine). The cam sensor provides this information (as there is only one cam revolution per engine cycle for a 4 stroke engine).

Cam Sensor 1		
Cam1 Hi Gain Below	2000	rpm
Cam1 Lo Gain Above	1900	rpm
Cam1 Rising Edge	OFF	
Cam1 Falling Edge	ON	

- Cam1 Lo Gain Above** Some VR cam sensors give too high an output at high engine speeds. This feature allows the sensitivity of the ECU to be switched to lower above the set engine speed to allow for this. Typically 1500rpm.
- Cam1 Hi Gain Below** High channel sensitivity when below this value. Should be set below the on value (hysteresis). Logic level sensors (hall effect) set to 0
- Cam1 Rising Edge** rising edge of the crank signal is used as the significant edge if ON. Typically **OFF**
- Cam1 Falling Edge** falling edge of the crank signal is used as the significant edge if ON. Typically **ON**

The cam input can be from either a MVR or Hall sensor. Jumpers on the board must be set to allow for these two sensor types.

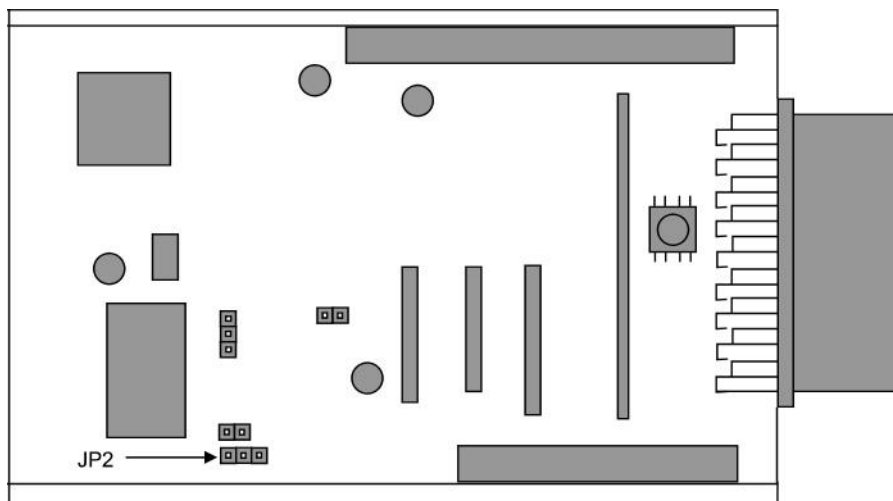

Sensor Type	Jumper Position	
Typical MVR	none	<input type="checkbox"/> <input type="checkbox"/> <input type="checkbox"/>
High Output MVR	1 2	<input checked="" type="checkbox"/> <input type="checkbox"/> <input type="checkbox"/>
Hall Effect	2 3	<input type="checkbox"/> <input checked="" type="checkbox"/> <input type="checkbox"/>

5.11 Cam2 Sensor

The Cam2 sensor is used for some engines, typically twin VVC engines.

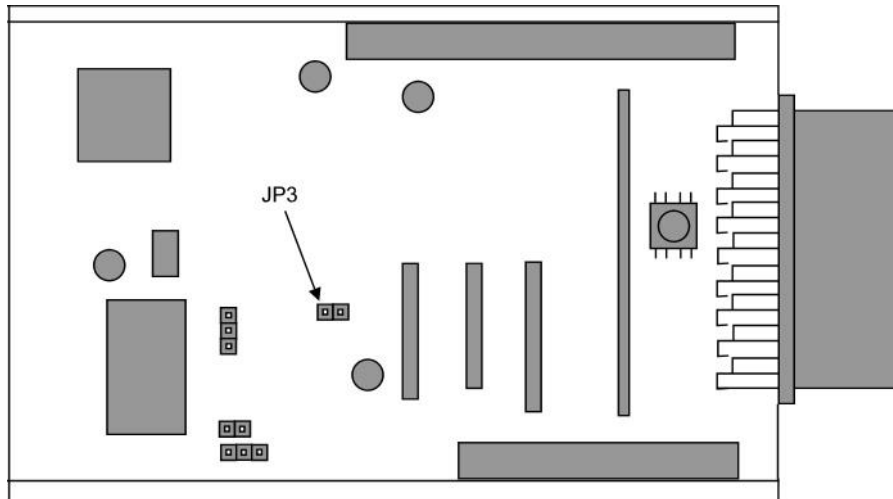

Sensor Type	Jumper Position
Typical MVR	OFF
Hall Effect	ON

5.12 Ignition Timing Alignment

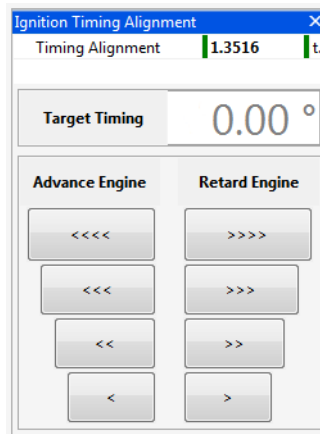

The ECU recognises the engine position by a missing or extra tooth on a pattern of evenly spaced teeth. Different manufacturers have this reference in a different place on the trigger wheel so the ECU needs to have adjustment for this. The numbers are known for most manufacturers and will be set in the start-up calibration but if they are unknown or if you are using an Omex external 36-1 wheel, you will need to find this value yourself. To find this value you will need a strobe light and an accurate TDC mark on the engine.

- Hold the engine at 2000-3000 rpm (ie out of the idle condition where the ignition timing is stable)
- Check the engine speed shown on the strobe light. Most strobe lights will see the wasted spark on DIS systems and so will show double engine speed and so also double ignition timing. If this is the case then halve all ignition timing figures shown on the strobe light.
- Check the ignition timing with a strobe light and compare this number to the number in **Target Timing**.
- If the engine is retarded compared to **Target Timing** (the strobe light shows a lower value) then advance the engine. If the engine is advanced compared to **Target Timing** (the strobe light

shows a higher value) then retard the engine. The larger buttons make larger changes, the smaller buttons make smaller changes. The **Target Timing** on the PC will not change, but the timing mark on the engine will move, so each adjustment will require the strobe light resetting. Repeat these changes until the strobe light timing figure agrees with the **Target Timing** figure.

If you cannot get the engine to start and believe this is because the ignition timing is incorrect then you can perform the above tests whilst cranking the engine. Timing lights will not work correctly during normal cranking as the engine speed varies so much due to the compression of each cylinder. Therefore the spark plugs should be removed (to remove compression), put back into the HT leads, and placed onto an earthed part of the engine, then the process documented above can be followed but at cranking speeds. When this is done and you get the engine started, it should be repeated at normal running speeds.

6 Map Axes

6.1 Engine Speed

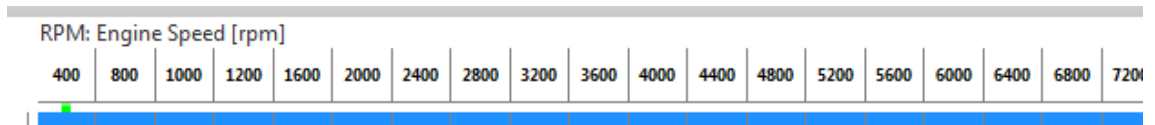

All maps (fuel, ignition etc) use the same rpm axis. You can adjust this axis on any of the maps and it will affect all of them. Typically the RPM axis would have a value towards stall as the first site (450rpm), a site just below the target idle speed, a site on the target idle speed, a site just above the target idle speed, then the rest of the sites evenly spaced to complete the engine speed range, the final site being just above the rev limit. On some engines it may be useful to increase the density of sites around areas where the fuel and ignition requirements change rapidly e.g. where an engine ‘comes onto cam’.

6.2 Engine Load

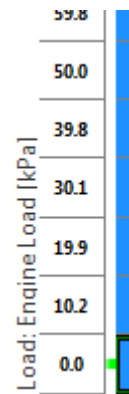

There are several choices for engine load reading;

Normal Aspirated

- TPS for load (preference due to giving best throttle response and easy mapping)
- MAP for load

Turbocharged / Centrifugal Supercharged

- MAP for load
- Boost Correction fuel mapping with MAP for load ignition mapping

Positive Displacement Supercharged

- TPS for load
- MAP for load

TPS for load

MAP Sensor	
MAP for Load	OFF
Load Scalar	1.0000
Load Offset	0.0000
MAP Cal	12 Teeth
MAP min	0
MAP max	255

Fuel Map Throttle	
Fuel Map Throttle	OFF
Boost correction	OFF

Select this mode by ensuring **Standard | Sensor Setup | MAP Sensor | MAP for load = OFF**. All options found in **Advanced | Boost Correction** must be **OFF**. The load axis will read kPa but this is actually 0-100% throttle. All maps (fuel, ignition etc) will use the same load axis. You can adjust this axis on any of the maps and it will affect all of them. Typically, the sites would be evenly spaced through the throttle range, maybe with closer sites at light throttles.

MAP for Load

MAP Sensor		
MAP for Load	ON	
Load Scalar	1.0000	
Load Offset	0.0000	
MAP Cal	12	Teeth
MAP min	0	
MAP max	255	

Fuel Map Throttle	
Fuel Map Throttle	OFF
Boost correction	OFF

Turn on MAP for load and scale the MAP sensor as described in the earlier 'MAP sensor for engine load' section of this manual. . All options found in **Advanced | Boost Correction** must be **OFF**. All maps (fuel, ignition etc) will use the same load axis. You can adjust this axis on any of the maps and it will affect all of them. The load axis of the map should have the lowest site as the minimum MAP value on overrun, the next site up is the MAP value at warm idle, the top site should be set to just above the maximum manifold pressure that will be run by the engine, then the sites in between evenly spaced and maybe more densely placed below 100kPa than above.

Boost Correction fuel mapping with MAP for load ignition mapping

MAP Sensor		
MAP for Load	ON	
Load Scalar	1.0000	
Load Offset	0.0000	
MAP Cal	12	Teeth
MAP min	0	
MAP max	255	

Fuel Map Throttle	
Fuel Map Throttle	ON
Boost correction	ON

Ensure **MAP for Load** is **ON** and the MAP sensor is scaled as described in the sensor setup section of this manual. Set **Advanced | Boost Correction** all options **ON**. The **Ignition Map** load axis will be MAP for load. This should have the lowest site as the minimum MAP value on overrun, the next site up is the MAP value at warm idle, the top site should be set to

just above the maximum manifold pressure that will be run by the engine, then the sites inbetween evenly spaced and maybe more densely placed below 100kPa than above.

The **Fuel Map** load axis will be marked Throttle Angle. Typically, the sites would be evenly spaced through the TPS range, maybe with closer sites at light throttles.

The fuel trim at any given manifold pressure is set in the Boost Fuel Correct Table.

The correction should be set to 0 at 100kPa.

7 Basic Fuel Setup

The amount of fuel injected each cycle is dependent on the time the injector is open. This time period (or pulse width) is calculated by the ECU using the values found in the main fuel map and all of the modifiers such as transient fuel, cold start enrichment etc.

On the main fuel map, at each intersection of an engine speed site and an engine load site there is a grid value. This is the VE value and is directly proportional to the pulse width and therefore the amount of fuel injected.

These values are determined by running the engine on a dynamometer at each obtainable point and adjusting the VE values to obtain optimum performance. (ie mapping the engine).

If the engine is running at an exact engine speed site and an exact engine load site then the VE value at the intersection of these two sites will determine the amount of fuel injected. If running at a condition where it is not exactly on a mapped site, the ECU interpolates between the nearest sites.

The fuel pulsewidth from the main fuel map is calculated as follows;

$$\text{Base fuel pulsewidth} = \text{raw (map) value} \times \text{Microsec/bit}$$

As a starting point it is quite acceptable to set **Microsec/bit** to 50. This will give a very good starting point for most engine setups. Once a sample full throttle point around maximum torque has been trial mapped, the **Microsec/bit** can be adjusted to give a maximum fuel map setting of 200 or so. If working from a reasonable start-up calibration, set the engine to be very slightly rich overall by adjusting **Microsec/bit**, then map sites from this point. Once a rough calibration is made, the fuel map can be rescaled (see below) to give better resolution.

Fuel Sync is the overall injection start point delay measured in internal units, A change in value of 1 is a change in start point of 30 crank degrees. This number can be changed to give the best emissions or power.

Fuel maps have six additional commands in the pop-up menu. Three **View** commands change the units the map is displayed in. The other three commands alter the fuel map to achieve better scaling.

View commands

Available by a right-click on the fuel map, a pop-up menu gives three view commands to select the units the fuel map is displayed in. Only one view command can be checked at any one time.

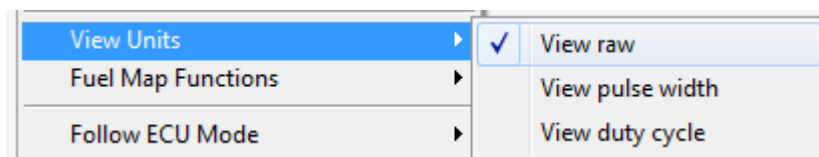

- **View raw** - Shows the raw value of the map as stored in the ECU. These are the values that should be used during engine mapping. It has a range of 0 to 255. When selected, the caption of the map window shows **Raw**.
- **View pulse width** - Shows the actual injector pulse width in milliseconds before any modifications. When selected, the caption of the map window shows **Pulse Width**. This view mode should be used for reference only, not for inputting data whilst mapping.
- **View duty cycle** - Shows the percentage of time that the injectors are actually open. When selected, the caption of the map window shows **Duty Cycle**. In order for MAP4000 to correctly calculate the duty cycle, when **View duty cycle** is selected, it prompts for the number of injections per engine revolution. This view mode should be used for reference only, not for inputting data whilst mapping.

Fuel map rescaling

Available by a right-click on the fuel map, a pop-up menu gives commands for altering the fuel map;

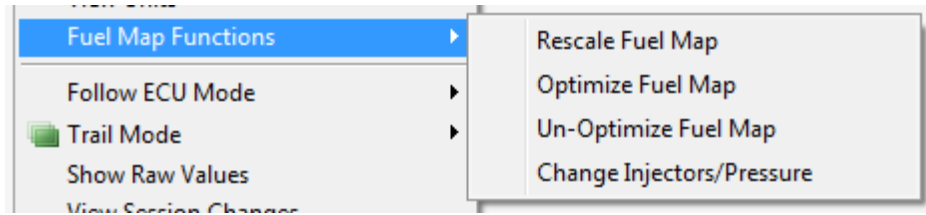

- **Rescale fuel map** - This changes the fuel map values and the option **Microsec/bit** such that the pulse width for every site remains constant but the maximum value in the fuel map is adjusted to 240. This therefore gives near maximum resolution, with an amount of headroom should the maximum torque point require a longer pulsewidth later in the tuning.
- **Optimize fuel map** – Rarely used. Do not use this option on an engine that is already mapped. This changes the fuel map values, the option **Microsec/bit** and the option **LDOMPC** such that the resolution is increased throughout the fuel map by non-linearising the raw values. This is particularly useful when calibrating fuelling for low load sites and stable idling on high boost engines.
- **Change injectors / pressure** - This allows the fuel map to be rescaled to accommodate a change in injector size and/ or fuel line pressure. When selected, the *Resize Injectors* dialog is shown:

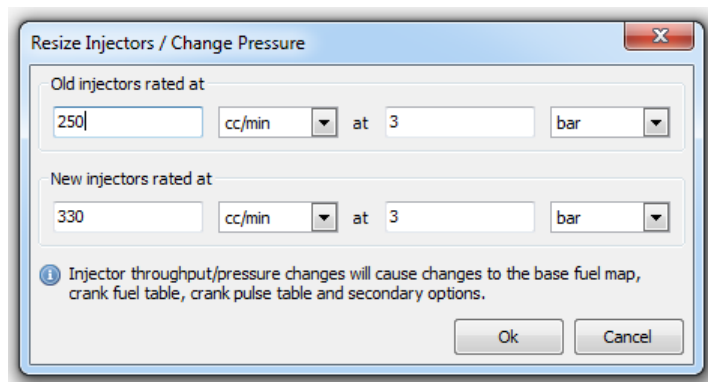

To use this dialog;

Enter the specification of your fuel system before modification and after modification and MAP4000 will alter your fuel related maps and tables to suit.

7.1 Battery Voltage Compensation

An injection period is made up physically of 2 time periods. The end period is when the injector is open and flowing fuel, and the first period is when the injector is opening its valve and there is no flow of fuel. At low injector durations, this period where the injector is reacting but not flowing fuel can be significant.

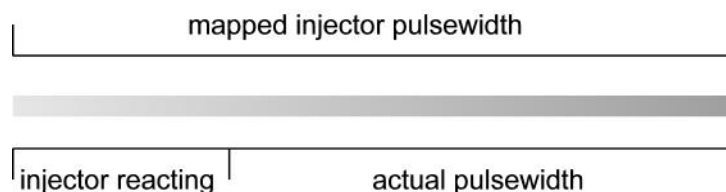

This time period of no flow varies in length with battery voltage and with fuel pressure. This also varies between injector models. Were an engine to run at a constant voltage, then there would be no problems as the injector reaction time would be a constant length. However, the injectors do see a varying voltage so the ECU needs to allow for this varying period of no fuel flow, and as all types of injector react differently, it needs to be told this information by the user. The information is held in the ECU in the **Battery Comp table. Standard | Conditions Corrections | Fuel | Battery Voltage.**

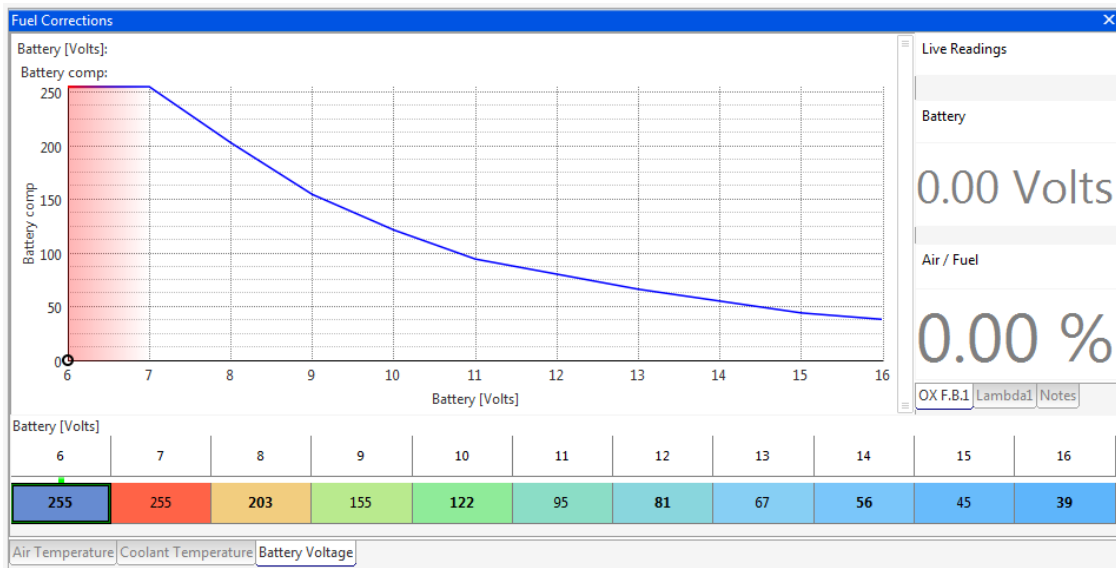

The battery voltage compensation data can usually be supplied by the injector manufacturers. For example, the Weber IW 058 injector data is for 3bar fuel pressure,

Battery Volts	Offset time mSec
8.0	2.03
10.0	1.22
12.0	0.81
14.0	0.56
16.0	0.39

The Omex ECU can not take the data in the form of offset time in msec, it instead requires the table to hold the data as a number between 0 and 255 which is then scaled. If using offsets from injector manufacturers simply multiply the offset time, usually stated in mSec, by 100.

Battery Volts	Battery Comp
8.0	203
10.0	122
12.0	81
14.0	56
16.0	39

The missing values for odd voltages are best blended using the graphical display of **View | Battery Comp Table | graph**

If this information is unavailable for your injector, then you will need to find these values yourself.

- Connect a power supply to run the injectors and ECU at variable voltages
- Set the voltage to one of the sites in the Battery Comp Table near to the normal running voltage of the vehicle, typically 14V.
- Map an area of the fuel map to a constant AFR (this area should be out of idle so the engine is steady)
- Change the voltage of the power supply to one of the voltages on the **Battery Comp table**
- The lambda reading may change. If so, change this voltage's value in the **Battery Comp table** to return the lambda to the original reading

- Repeat this for all of the possible voltages

If a power supply is unavailable, then an attempt can be made to bring down the voltage in road cars by turning on lights, heater blowers etc.

8 Rev Limits

The **Fuel Cut RPM table** and **Ign Cut RPM table** allow differing rev limits based upon throttle position for when using anti-lag. If you are not using anti-lag, set all of the throttle positions in the table to the same engine speed. An example of a 6000rpm limit is as follows.

Ign Cut RPM Table Grid										
Throttle Angle: Throttle [%]										rpm
0.0	10.2	19.9	30.1	39.8	50.0	59.8	69.9	79.7	89.8	99.6
6000	6000	6000	6000	6000	6000	6000	6000	6000	6000	6000

Ign Cut RPM Table Grid Fuel Cut RPM Table Notes

At this engine speed, the soft cut will be invoked. If the engine speed is exceeded by 50 rpm, then the hard cut is invoked. *If you are not using a cam sensor so have semi-sequential fuelling, the **Fuel Cut RPM Table** should be set to an engine speed that is higher than the ignition cut rev limit.*

A second rev limit can be imposed when the engine is below a specified temperature.

Cold limit options		
Lo Limit Below Cool	20	°C
Lo Limit Offset	1000	rpm

Cold limit options Notes

Lo Limit Below Cool
Lo Limit Offset

the temperature below which the cold rev limit is set
 the reduction in rev limit when rev limit coolant is satisfied

9 Dashboard

9.1 Tacho

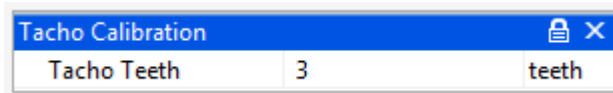

The frequency of pulses for the tacho is set by the option **Tacho Teeth**. Adjust this number until the tacho reads the correct engine speed. The correct setting for a 4cylinder tacho is 3.

9.2 Shift Light



If using a single shift light engine speed for all gears then the engine speed at which the light is turned on is set by the option **Shiftlight On RPM**;

9.3 Gear dependent shift light speed

Shiftlight per gear		
rpm	7	6000
	6	6000
	5	6000
	4	6000
	3	6000
	2	5500
	1	5000
GEAR []	0	5000

For this control a road speed sensor must be fitted and calibrated, and gear recognition must be calibrated.

10 Engine Start Condition

During cranking the fuel and ignition are not controlled by the main fuel and ignition maps, but instead by separate tables and options.

The cranking condition is defined by the engine speed options **Min RPM** and **Start Exit RPM**. **Min RPM** is the engine speed at which the engine is considered to start cranking (typically 50 rpm), and **Start Exit RPM** is the engine speed above which the engine is considered to be under normal running ie no longer cranking (typically 400rpm)

Min RPM	50.00	rpm
Start Exit RPM	400	rpm
Start Ignition	1.99	°

10.1 Ignition

Whilst cranking, the ignition timing is determined by the **Start Ignition** option. This is set in degrees and would normally be a low value eg 2 degrees.

Min RPM	50.00	rpm
Start Exit RPM	400	rpm
Start Ignition	1.99	°

10.2 Fuel

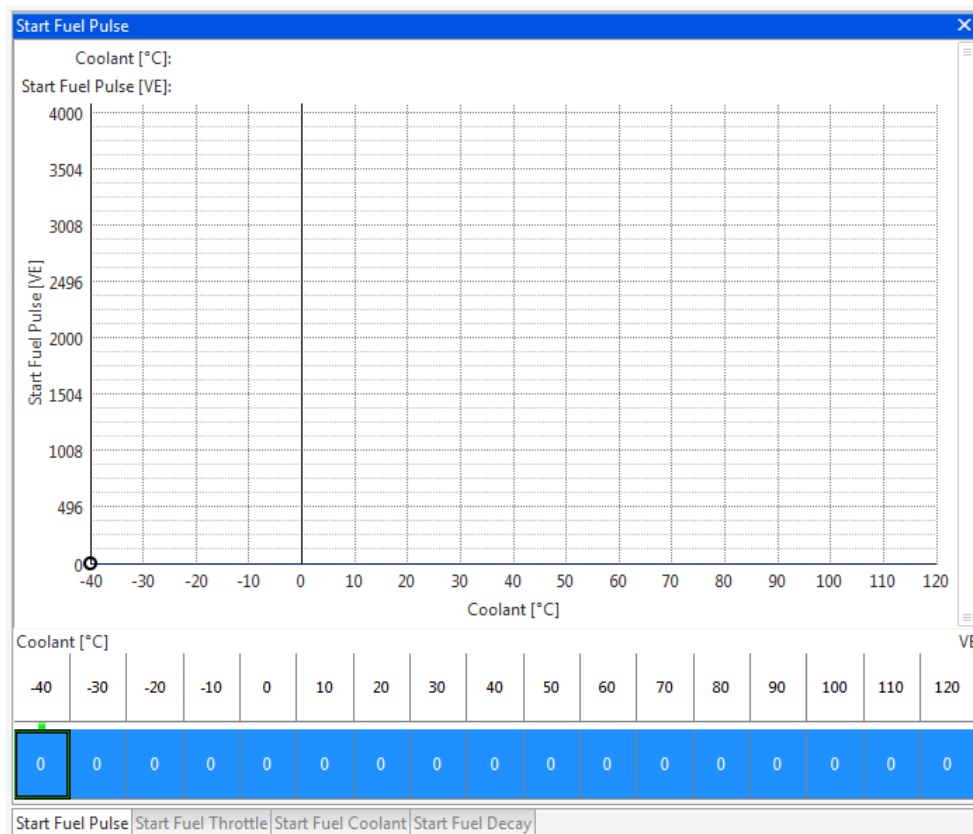

Start Fuel Throttle Table – This is the amount of fuel injected in cranking, dependent on throttle position, while the engine is starting. This value is VE (same as the main fuel map) so is multiplied by **Microsec/bit** to give the fuel pulsewidth.

Start Fuel Coolant Table – Extra percentage of fuel added to the Start Fuel Throttle due to temperature.

Start Fuel Decay Table – This determines how quickly the additional start fuel decays over time. This is a linear decay in seconds after cranking commences.

Start Fuel Pulse Table- This is an extra single injection of fuel that is injected at the very start of cranking. This value is VE (same as the main fuel map) so is multiplied by **Microsec/bit** to give the fuel pulsewidth.

Setting-up start fuel

It is important to note that the **Coolant Fuel Trim table** is always active, even under cranking conditions, and so the cold engine running must be completed before the cold starting can be fully calibrated.

The **Start Fuel Throttle table** very rarely requires changing from Omex's standard values. The standard values have 0 fuel at 100% throttle, allowing a flooded engine to be cleared by using full throttle whilst cranking.

In general, an engine that has too much starting fuel will start and then immediately stop again. If there is a very large excess of fuel, the engine may even 'kick back' as if it were too far advanced on the ignition. An engine with too little starting fuel will crank for a long time before the engine will start. Both of these situations call for a change to both the **Start Fuel Pulse table**, and the **Start Fuel Coolant table**. If the engine starts but will not rev freely for the first few seconds of engine running, then the **Start Fuel Decay table** usually requires adjusting.

11 Idle Strategies

The 710 series ECU can control idle using spark scattering, push/pull motors and stepper motors.

The idle condition is entered by the options **Idle on Below RPM**, and **Idle On Throttle**. The engine must be below both of these values to enter idle.

The normal warm target idle speed that the ECU attempts to maintain is set by **Idle FB Target RPM**.

Normal Idle		
Idle On Throttle	1.95	%
Idle On Below RPM	1600	rpm
Idle FB Target RPM	950	rpm

A high idle will be required in some conditions. The ECU can set a high idle speed based on coolant temperature (**Idle Hi Below Cool**), or as engine speed drops towards idle to give a 'soft' return to idle (**Idle Hi Time** and **Idle Hi Decay**). The target idle increase above the normal idle speed for high idle is **Idle Hi FB Target+**. When returning to the idle condition the target speed is the 'Hi' speed for **Idle Hi Time** then reduced to the normal idle speed over a period of time set by **Idle Hi Decay**.

High Idle		
Idle Hi Below Cool	50	°C
Idle Hi time	0.26	S
Idle Hi Decay	0.13	S

11.1 Without air bypass idle motor

If there is no idle motor on the engine then just the scatter spark idle is used.

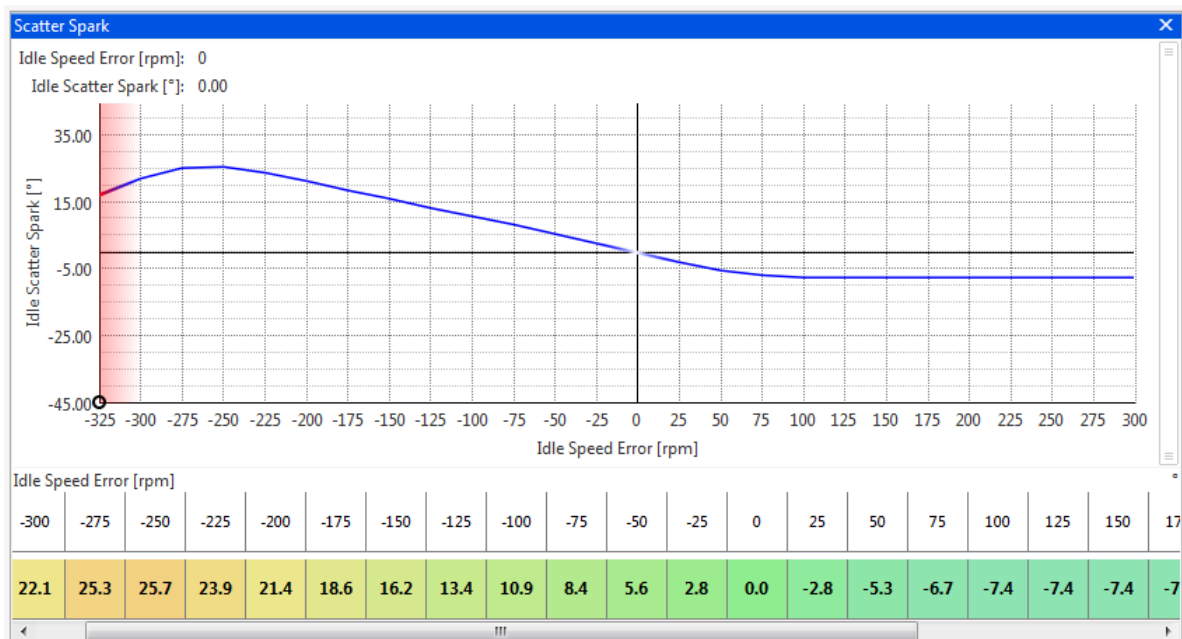

The **Idle Scatter Spark Table** shows the change in ignition timing based upon rpm away from the target engine speed. When the engine speed is higher than target negative values are required to

decrease the idle rpm, and when the idle is lower than target positive values are required to increase the idle rpm. As the engine moves further away from the target speed, the numbers should increase.

Setting idle scatter control

- Turn the scatter spark control off by setting **Idle On Below RPM** to **100rpm** so that the engine will not enter the idle condition.
- With the engine warm set the natural idle (through adjusting air bleed screws or if necessary, the throttle stop, remembering that if the throttle stop is moved, **TPS min** must be reset) to approximately **150rpm** higher than the target idle speed.
- Turn the scatter spark idle control back on by resetting the **Idle On Below RPM** option to its previous value.
- Blip the throttle and the engine speed should return to the **Idle FB Target RPM** value.

As the engine is being given more air than is required to idle the engine when warm it retards the ignition whilst in the idle condition to maintain the target engine speed. When the engine is cold it requires more air to idle and so it benefits from the extra air, the ignition is advanced whilst in the idle condition, and the engine has an improved cold idle speed.

Setting Hi Idle

With scatter spark control you simply set the Hi Idle options. As there is no idle motor to give the engine extra air, the ECU will attempt to hold the Hi Idle speed, but will not be able to match it when the engine is cold.

11.2 With air bypass idle motor

There are three types of air bypass motor; 2 wire spring return, 3 wire push/pull, and stepper motor.

Air Bypass Valve		
Idle Duty Min	0.00	%
Idle Duty Max	0.00	%
Idle FB+ max	0	%
Idle FB- max	0	%
Idle FB Rate	0.00	mS
Idle Rate	0	mS
Idle Reset Rate	0	mS
Idle Step Park	0.00	%

Idle Duty Max is the duty cycle above which the idle motor does not flow extra air.
Idle Duty Min is the duty cycle below which the idle motor does not flow any air.

The **Idle Duty Coolant table** gives the % opening of the idle motor required at each temperature to achieve the base target idle.

The **Idle Duty RPM table** is a modifier based on engine speed for if the engine speed moves below the target idle ie anti-stall. The target idle speed should have a modifier of **0**. Engine speeds well below target should have a large positive number to open the idle motor to stop the engine stalling. The example below is typical for a 1000rpm idle.

The idle is then fine-tuned and maintained by the feedback loop. **Idle FB- max** and **Idle FB+ max** are the feedback limits for the idle motor. The update rate of this feedback loop is set by **Idle FB Rate**. This would typically be **40ms** with a stepper motor or **200ms** with a PWM device.

The **Idle Fuel table** is required for engines that are using air bypass with throttle position as the main load sensor. On TPS load based engines, the load sensor (the TPS) does not measure the extra air flow due to the opening of the idle motor, so does not compensate with extra fuel in the main fuel map to maintain the target lambda (air/fuel ratio). An oxygen sensor cannot make adjustments to the fuelling fast enough to cope with these changes. This table allows a fuel trim based on idle motor duty to maintain a constant lambda value. This is not required for MAP based systems so would be set to 0 in this case.

Testing correct operation of a 2 wire idle motor

- Remove the idle motor from the engine.
- Ensure that the idle motor has a constant power supply. If powered from a relay controlled by the ECU you will need to temporarily 'bridge across' this relay to give the idle motor constant power.
- In the **Idle Duty Coolant Table** find the current engine temperature and set that site and the sites either side to **0** which should close the valve. Set the sites to **100** and the valve should move to fully open. Some idle motors (usually Bosch parts) are slightly open when at a value of **0**, then close at about **30**, then start to open again until fully open at **100**. The value at the closed position must be inputted to **Idle Duty Min**.

Testing correct operation of a 3 wire idle motor

- Remove the idle motor from the engine.
- Ensure that the idle motor has a constant power supply. If powered from a relay controlled by the ECU you will need to temporarily 'bridge across' this relay to give the idle motor constant power.
- In the **Idle Duty Coolant Table** find the current engine temperature and set that site and the sites either side to **0** which should close the valve. Set the sites to **100** and the valve should move to fully open. If the opposite happens i.e. the valve is fully open at a value of **0** then either swap the 2 IDLE wires at the idle motor connector or swap the **Idle PWM1 out** and the **Idle PWM2 out**.
- Some idle motors (usually Bosch parts) are slightly open when at a value of **0**, then close at about **30**, then start to open again until fully open at **100**. The value at the closed position must be inputted to **Idle Duty Min**.

Testing correct operation of a 4 wire stepper motor

- Turn ignition off.
- Remove the stepper motor from the engine.
- Hold the stepper motor with the plunger facing very close (approximately 5mm) to a hard object.
- Ignition on. The stepper motor's plunger should push outwards for approximately 1 second then retract slightly. As it pushes out you must resist this by pushing it against a hard surface else the plunger can fall off.
- If the opposite happened i.e. the plunger retracted for a second, then pushed outwards slightly, either swap the IDLE1 and IDLE2 wires at the stepper motor or swap the setting of **Idle1 Stepper Out** and **Idle2 Stepper Out**.

Setting air bypass idle control on MAP for load engines

As the idle motor opens and closes, the manifold pressure changes and so the position on the main fuel maps moves, meaning the fuel requirement changes will be compensated for by the main fuel map. Therefore, ensure that the **Idle Fuel table** is set to 0 throughout. Ensure that all **Fuel Map** sites around idle (including those towards stall) are correctly calibrated before attempting this setup for the final time.

- Turn the scatter spark control and motor feedback control off by setting **Idle on below RPM** to **100rpm** so that the engine will not enter the idle condition.

- Set **Idle Hi FB Target +** to **0** so that the engine always has the same target idle speed.
- If there is an adjustable air bleed screw or an adjustable throttle stop, set all warm temperatures in the **Idle Duty Coolant table** (typically above 60degrees) to **0**, then with the engine warm set the natural idle to 100 or 200rpm below the target idle speed using the throttle stop or air bleed screw (note that if you move the throttle stop you must reset **TPS min**), then increase all hot temperatures in the **Idle Duty Coolant table** to a value which allows the engine to idle at the target idle speed. If there is no mechanical idle adjustment then set all hot temperatures in the **Idle Duty Coolant table** to a value which allows the engine to idle at the target idle speed.
- Turn the scatter spark control and motor feedback control back on by resetting the **Idle on below RPM** option to its previous value. (typically 500rpm above the normal target idle speed).
- Blip the throttle and the engine speed should return to the **Idle FB Target RPM** value.
- Follow the Setting Hi Idle instructions below.

During cold running setup of the fuelling, you will also need to adjust the **Idle Duty Coolant table** at each temperature to ensure that the feedback controls have to do as little work as possible. As a start point set all cold temperatures to 10% higher than the warm temperatures. The feedback work can be seen in parameter **Idle Set**. If **Idle Set** is a positive number then increase the current value in the **Idle Duty Coolant table**, or if negative, then reduce it.

Setting air bypass idle control on TPS for load engines

On TPS load based engines, the ECU does not measure the extra air flow due to the opening of the idle motor, so does not compensate with extra fuel in the main fuel map to maintain the target lambda (air/fuel ratio). An oxygen sensor cannot make adjustments to the fuelling fast enough to cope with these changes. The **Idle Fuel table** allows a fuel trim based on idle motor duty to maintain a constant lambda value. To set this table correctly, the engine must be held at the idle target speed whilst the engine is put under varying loads to alter the opening of the idle motor. This can be achieved through the use of a rolling road to apply the load, or simply by holding the brakes of the vehicle and gently releasing the clutch to load the engine. The table should then be altered to provide the extra fuel required to maintain a constant lambda value.

1. Get the engine to normal running temperatures
2. Set **Idle Hi FB Target +** to **0** so that the engine always has the same target idle speed.
3. Set **Idle FB+ Max** and **Idle FB- Max** both to **0**.
4. Set the whole of the **Idle Scatter Spark Table** to **0** (noting the values in this table as you will need to re-enter them later)
5. Set the whole of the **Idle Duty Fuel Trim Table** to **0**.

If there is an adjustable air bleed screw or an adjustable throttle stop;

6. Set all warm temperatures in the **Idle Duty Coolant table** (typically above 60degrees) to 0, then with the engine warm set the natural idle to approximately 250rpm below the target idle speed using the throttle stop or air bleed screw (note that if you move the throttle stop you must reset **TPS min**). Ensure that the engine is running at the correct AFR as the wrong AFR will make the engine run slowly. Change the fuelling in the main **Fuel Map** as required to maintain the correct AFR.
7. Set the whole of the **Idle Duty Fuel Trim Table** to 30%
8. Increase all hot temperature values in the **Idle Duty Coolant table** to a value which allows the engine to idle at the target idle speed whilst simultaneously adjusting the fuel map to achieve the correct AFR at the idle speed.
9. Ensure that the main **Fuel Map** is calibrated correctly down to stall speeds and at both closed throttle and the first site above closed throttle. This is best achieved through loading the engine on the dyno. Typically, as the engine goes towards stall speeds, there is a large increase in fuelling requirements.
10. In the **Idle Duty Coolant Table**, set various openings of the idle motor from 0-100%, load the engine on the dyno to hold (approximately) the target idle speed, then adjust the **Idle Duty Fuel Trim Table** to maintain the correct AFR.
11. Return all warm temperature values in the **Idle Duty Coolant Table** to a value that maintains the target idle speed.

If there is NOT an adjustable air bleed screw or adjustable throttle stop;

6. Set the whole of the **Idle Duty Fuel Trim Table** to 30% and set all hot temperatures in the **Idle Duty Coolant table** to a value which allows the engine to idle at the target idle speed. Ensure that the engine is running at the correct AFR as the wrong AFR will make the engine run slowly. Change the fuelling in the main **Fuel Map** as required to maintain the correct AFR at the idle speed.
7. Ensure that the main **Fuel Map** is calibrated correctly down to stall speeds and at both closed throttle and the first site above closed throttle. This is best achieved through loading the engine on the dyno. Typically, as the engine goes towards stall speeds, there is a large increase in fuelling requirements.
8. In the **Idle Duty Coolant Table**, set various openings of the idle motor from 0-100%, load the engine on the dyno to hold (approximately) the target idle speed, then adjust the **Idle Duty Fuel Trim Table** to maintain the correct AFR.
9. Return all warm temperature values in the **Idle Duty Coolant Table** to a value that maintains the target idle speed.

Setting Hi Idle

When the engine enters Hi idle conditions, the option **Hi Idle Duty** is the increase in duty cycle required to reach the **Hi Idle Target RPM+**. **The Hi Idle Target RPM+ would typically be 200 or 300rpm.**

- With the engine warm, fix the Hi Idle condition permanently on by setting the temperature entry condition, **Hi Idle below Cool**, to **120degrees**.
- Watch parameter **Idle Set** to see the increase in idle duty required to hold the higher engine speed.
- Enter the **Idle Set** value into **Idle Hi Duty**.
- Reset **Idle Hi Below Cool** to a suitable cold running value eg below **60degrees**.

Setting Aircon Idle

When an air conditioning pump switches ON, the load on the engine increases and so the idle speed will momentarily decrease. The idle feedback loop will allow the idle speed to recover, but the **Idle A/C Duty+** option is an instant increase in idle motor duty when the A/C input is ON so that the momentary dip in engine speed is reduced.

12 Transient Conditions

The fuel map contains the fuel for steady state running. Rapid throttle movements require extra fuelling.

12.1 Acceleration Fuel Basic

Triggering		
TPS Filter	50.00	%
dThrottle Trigger	3	
dLoad Trigger	5	

Accel fuel starts from the parameter **+dThrottle**. This parameter shows you the rate of change of throttle position. **+dThrottle** can be modified by **TPS Filter**. This option allows you to filter out noise and small throttle movements that should not trigger accel fuel. The lower the value, the greater the filtering effect. So for any physical rate of change of throttle position, a lower **TPS Filter** will give a lower **+dThrottle**. Typically a value in the region of **50-25** will give sufficient filtering effect yet still give large enough **+dThrottle** values to calculate the accel fuel from.

Fuel Calculation		
Accel C	5	
Accel M	5	
Accel Limit	50	%
Accel Decay	50.00	%

Once you have a **+dThrottle** from a throttle movement, the next important option is **dThrottle Trigger**. This sets the minimum **+dThrottle** that triggers accel fuel calculations. Typically **3-5**. As soon as accel fuel is triggered the option **Accel C** gives a set amount of accel fuel. Every amount above the trigger point also gives **Accel M**. For example;

dThrottle Trigger = 3
Accel C = 10
Accel M = 3

+dThrottle of 3 would give accel fuel of 10 (Accel C)
+dThrottle of 4 would give accel fuel of 13 (Accel C + Accel M)
+dThrottle of 5 would give accel fuel of 16 (Accel C + 2xAccel M)

Regardless of the amount of accel fuel calculated by this, it is limited to a maximum extra percentage of the current fuelling by option **Accel Limit**.

The acceleration fuel is decayed over a number of engine revolutions set by the option **Accel Decay**. Low values decay the accel fuel very quickly, high values decay very slowly. It is the percentage of the accel fuel remaining after each engine revolution. So **0** will give the accel fuel on one revolution then nothing on the next, **100** will never allow the accel fuel to decay. To find the required value, have the engine loaded on the dyno and repeatedly trigger accel fuel. If the engine slowly goes rich then you need to decay the fuel faster.

Advanced

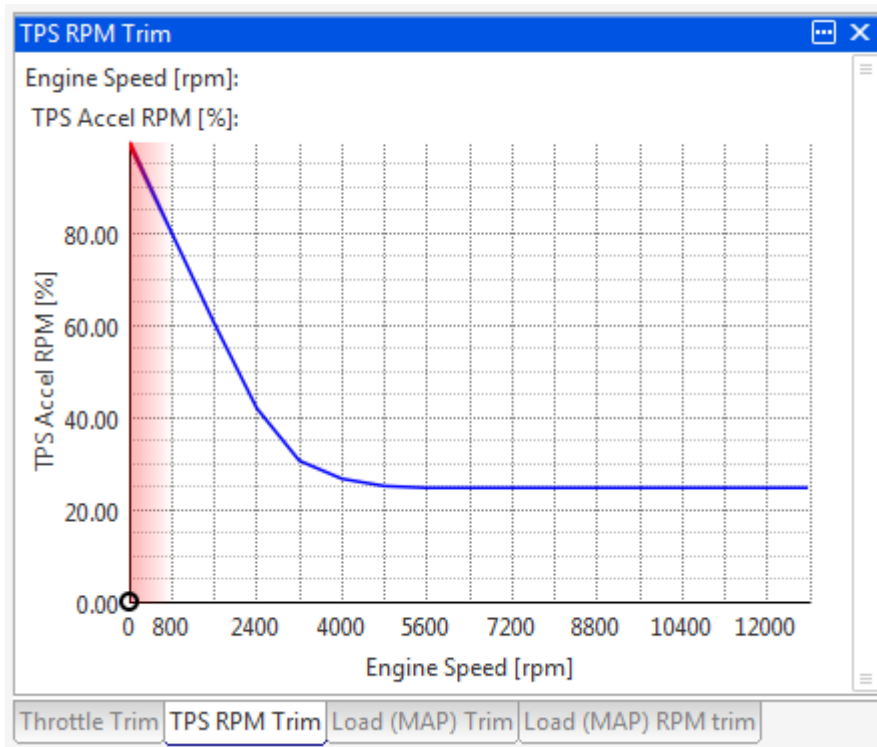

Engines usually require less acceleration fuel at high rpm, so the **TPS Accel RPM table** and **Load Accel RPM table** describe the percentage of the calculated fuel supplied at differing engine speeds.

The **Accel Throttle Trim table** and **Accel Load Trim table** allow the acceleration fuel to be modified for the throttle position or manifold pressure at which the acceleration fuel was tripped, therefore giving varying acceleration fuel at different engine loads.

When the engine is in warm-up, it may require extra acceleration fuelling. This is described in the **Accel Coolant Trim table** as a percentage extra acceleration fuel.

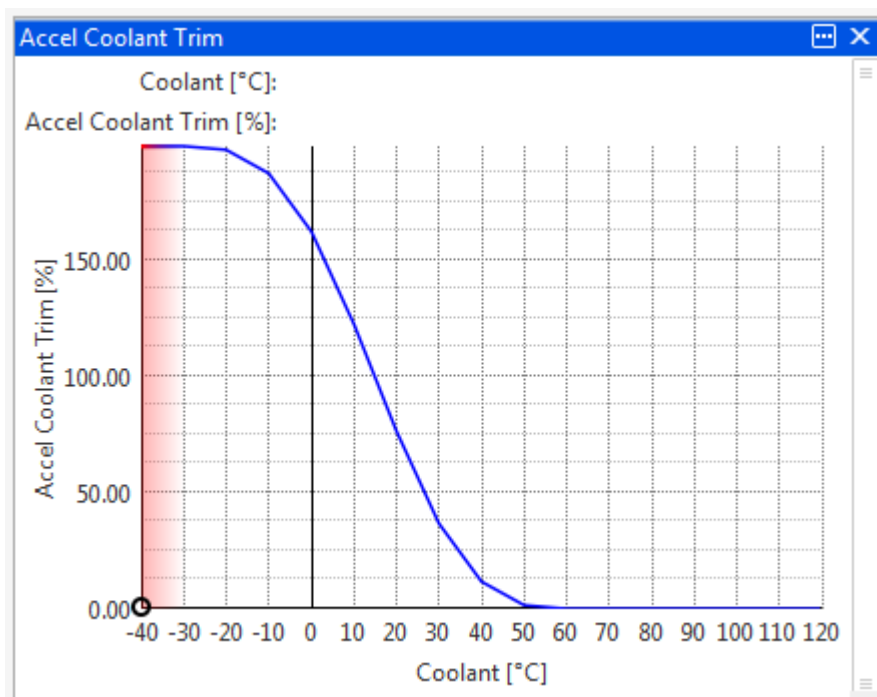

Tuning Warm-running Acceleration Fuelling

Your startup calibration will be preset with typical acceleration fuelling values, and if the engine ‘feels’ right then this is in many cases quite acceptable – engines will usually feel right when they have enough, or too much, acceleration fuelling, and will only feel wrong if there is too little fuel or far too much. On many engines the following very simple setup will be suitable;

- Get the engine to normal running temperatures
- Set the **TPS Accel RPM table** and **Accel Throttle Trim table** to 100% throughout
- Set **TPS Filter** to 75%
- Accelerating the engine in the most difficult condition, fast throttle movement from idle, adjust option **Accel Limit** until the engine accelerates at the maximum rate possible with no stumbles.
- Adjust **TPS Filter** to the lowest value possible that still gives engine acceleration without stumbles in all conditions.

For absolutely correct setup, the following procedure should be followed;

- Set the **TPS Accel RPM table**, **Accel Throttle Trim table**, and **Accel Coolant Trim table** all to 100% throughout.
- Disable the acceleration fuelling by setting the **dThrottle Trigger** value to an unobtainable value such as **100**.
- The condition that requires the most acceleration fuel is getting the engine to come up from idle so we start there. By viewing the parameter **+dThrottle** and gently pressing the throttle pedal, find the value of **+dThrottle** at which the engine will have a lean ‘stumble’ (this can be recognised either by a wideband lambda reading, or simply by listening to the engine and seeing when it stops ‘picking-up’ smoothly). Enter this value into option **dThrottle Trigger** (typically this would be **2** or **3**).
- With **Accel M** set to **1**, adjust **Accel C** until the engine will accelerate from idle with no lean stumble at a throttle movement just fast enough to trigger the acceleration fuel.
- Adjust **Accel M** until the engine will best accelerate from idle at the fastest rate of throttle movement that can be achieved.
- Accelerate the engine at the fastest rate of throttle movement possible, starting from the engine speeds shown in the **TPS Accel RPM table**. Reduce the values at each engine speed in this table to give the minimum possible value that still gives maximum engine acceleration or an acceptable lambda value.
- If using a rolling road, then it is also possible to trim the response based on throttle start position in the **Accel Throttle Trim table** as a load can be applied to the engine to allow the throttle to be held at varying % openings and the table trimmed based on the lambda values recorded.
- Tuning the **Accel Decay** also requires the use of a rolling road to get it perfect. With the vehicle being driven with load on it, repeatedly trigger acceleration fuel by pumping the throttle, but with the engine unable to accelerate too quickly due to the load on it. If the lambda values steadily go rich, then reduce the **Accel Decay** value, or if the lambda values steadily go lean, then increase the **Accel Decay** value.

Tuning Cold-running Acceleration Fuelling

The cold-running acceleration fuelling must be set whilst setting other cold running tables and options. Refer to the cold running section of this manual for further advice.

12.2 Deceleration Fuel Cut Off

When this function is active ie above the engine RPM and below the engine load, the injection pulsewidth is reduced to a minimum. This feature is not normally used on high performance and race cars as it is simply there to improve fuel economy slightly. To disable this feature set as follows.

Decel fuel cut off		
DFCO On Above RPM	25500	rpm
DFCO On Below load	99.61	kPa

13 Conditions Corrections

13.1 Coolant Temperature

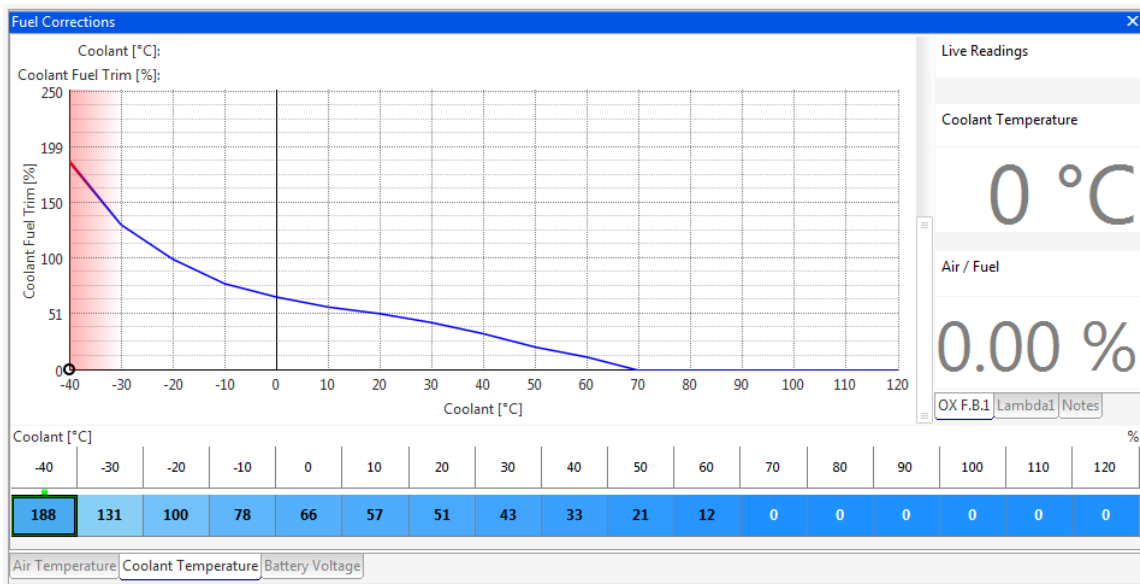

When the engine is cold, it requires an extra amount of fuel. This extra fuel is added as a percentage set in the **Coolant Fuel Trim table** of percentage increase against engine coolant temperature.

Ignition can be trimmed based upon coolant temperature. This is only used for extremes of temperature. This is described by the **Coolant Ignition Trim table**.

13.2 Air Temperature

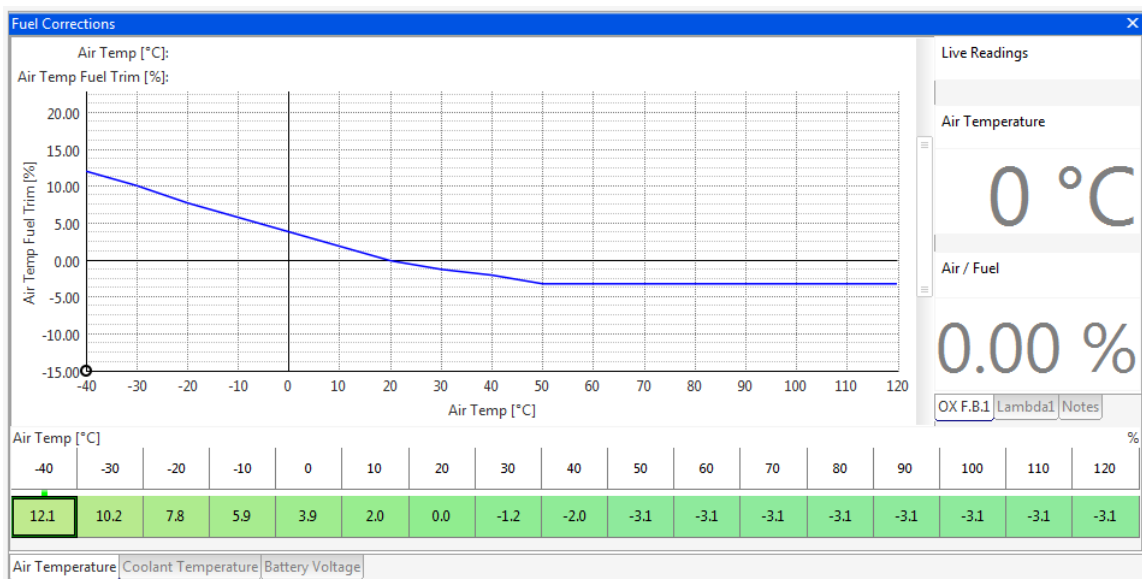

If you wish to change the fuelling with air inlet temperature, then the **Air Temp Fuel Trim table** allows the user to make a percentage change in fuel based on AIT.

Ignition can be trimmed based upon air inlet temperature. This is only used for extremes of temperature. This is described by the **Air Temp Ign Trim table**.

13.3 Barometric Pressure

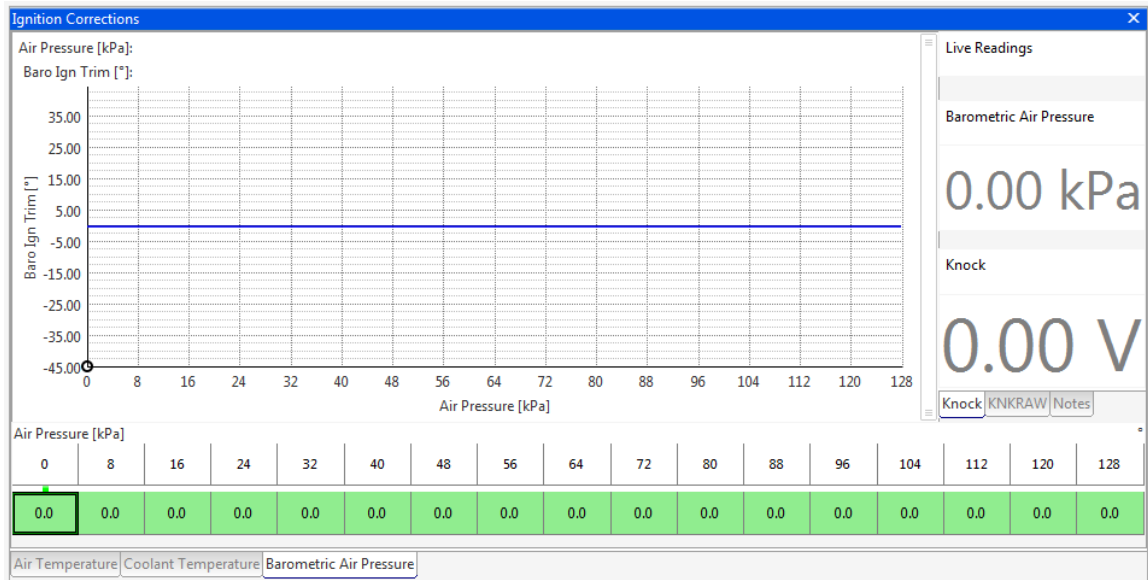

The fuel and ignition can be trimmed to allow for changes in barometric pressure as sensed by a 1bar pressure sensor. The ignition trim is defined in the **Baro Ign Trim table**. The fuel trim values are a known mathematical equation so are inbuilt and are non-adjustable.

13.4 Individual Fuel Output Trims

Each fuel output can have a percentage trim. This trim happens all of the time under all engine conditions. This would normally be set to all outputs 0%.

14 Cold Engine Running

When cold, engines require different amounts of fuel (and air) to run correctly. The method for setting-up the cold running and idle varies dependent on the load sensing and idle controls used. Note that the cold setup cannot be done until the engine is fully mapped for warm conditions as all of the cold running tables are modifiers on the warm running maps.

The below procedures may need to be followed several times to get the cold running correct, with the running improving by smaller amounts each time until perfect.

No idle air bypass motor

- Ensure that you have completed the warm idle and warm transient fuel setups before continuing.
- Arrange the screen so that you can see the **Coolant Fuel Trim table**, the **Accel Coolant Trim table**, and the parameter **Spark Idle**.
- Start the engine from cold any way possible. The cold running must be completed before the cold starting can be completed so do not worry too much about the starting.
- As the engine warms, watch the parameter **Spark Idle**. At all cold temperatures, adjust the values in the **Coolant Fuel Trim table** to give the lowest number possible in **Spark Idle**. When the **Coolant Fuel Trim table** is set at a particular temperature, blip the throttle and adjust the **Accel Coolant Trim table** to give the lowest number possible at which the engine still accelerates without stumbles.

With idle air bypass motor

- Ensure that you have completed the warm idle and warm transient fuel setups before continuing.
- Arrange the screen so that you can see the **Coolant Fuel Trim table**, the **Accel Coolant Trim table**, the **Idle Duty Coolant table**, and the parameters **Engine Speed** and **Idle Set**.
- Start the engine from cold any way possible. This cold running tuning must be completed before the cold starting can be completed.
- As the engine warms, adjust the **Coolant Fuel Trim table** to give the highest possible engine speed for the current idle motor opening, then adjust the **Idle Duty Coolant table** to make the **Idle Set** parameter read near **0**. This will be an iterative procedure as they both affect the engine speed. When these tables are set at a particular temperature, blip the throttle and adjust the **Accel Coolant Trim table** to give the lowest number possible at which the engine still accelerates without stumbles.

15 Oxygen Feedback

The ECU can take inputs from either narrowband or wideband oxygen sensors. This information is then used to make constant trims to the fuelling.

For banked engine with two exhausts, the ECU can take inputs of two lambda sensors. To assign the fuel outputs to the oxygen sensors, use the Ox FB Sensor Select option group.

Sensor1 injectors			Sensor2 injectors		
Fuel1 O2 FB1	OFF		Fuel1 O2 FB2	OFF	
Fuel2 O2 FB1	OFF		Fuel2 O2 FB2	OFF	
Fuel3 O2 FB1	ON		Fuel3 O2 FB2	OFF	
Fuel4 O2 FB1	OFF		Fuel4 O2 FB2	ON	
Fuel5 O2 FB1	ON		Fuel5 O2 FB2	OFF	
Fuel6 O2 FB1	OFF		Fuel6 O2 FB2	ON	
Fuel7 O2 FB1	OFF		Fuel7 O2 FB2	ON	
Fuel8 O2 FB1	ON		Fuel8 O2 FB2	OFF	
Fuel9 O2 FB1	OFF		Fuel9 O2 FB2	ON	
Fuel10 O2 FB1	ON		Fuel10 O2 FB2	OFF	
Fuel11 O2 FB1	OFF		Fuel11 O2 FB2	OFF	
Fuel12 O2 FB1	OFF		Fuel12 O2 FB2	OFF	

There is a large amount of theory, and many different options, involved in setting up the complicated oxygen feedback as this ECU is capable of meeting very strict emissions requirements. Fortunately, these complicated equations have already been tackled, and nearly all engines require the same settings for oxygen feedback, so it can be set relatively easily.

15.1 Narrowband Basic

Basic		
OX FB Below Load	60.16	kPa
OX FB Below RPM	4000	rpm
OX FB Coolant min	75	°C
OX FB Rate	0	mS

A narrowband exhaust gas oxygen sensor may be used to trim the fuelling to maintain a stoichiometric ($\lambda=1$) air/fuel mixture to enable the use of an exhaust catalyst. Any 3 or 4 wire (ie heated) narrow band lambda sensor can be used.

Start-up calibrations from Omex will be programmed with oxygen feedback numbers for narrowband sensor feedback so in most cases all that is required is to turn on the function.

- **OX FB Below Load** and **OX FB Below RPM** are the engine load and engine RPM values below which the oxygen feedback is active. Typically these cover the emissions test and gentle driving conditions. eg 4000rpm and 40% load
- **OX FB Coolant min** is the minimum engine coolant temperature at which the engine is able to run at lambda 1 ie the temperature at which it no longer requires warm-up fuel enrichment. Typically 60-70C.
- **OX FB Rate** is the update rate of the sensor, typically 100. Setting this to 0 disables the oxygen feedback.

Advanced

The following is a list of the maps, tables and options, typical values, and their use in oxygen feedback. It is strongly recommended that these values are not changed without consulting Omex.

OX FB +max and **OX FB –max** are the percentage fuel trim limits for the oxygen feedback.

Advanced		
OX FB min AFUEL	100	μS
OX FB+ max	19.92	%
OX FB- max	-25.00	%
OX FB P	5	
OX Raw Fail Hi	1.992	V
OX Raw Fail Low	0.000	V
OX Max Toggle	10000	cyc
OX FB Default	0.00	%
OX FB Gain	2	
OX FB wideband	OFF	

Oxygen Error table – If the feedback rate is not fast enough (the engine swings from rich to lean for long periods of time), then these numbers may be increased

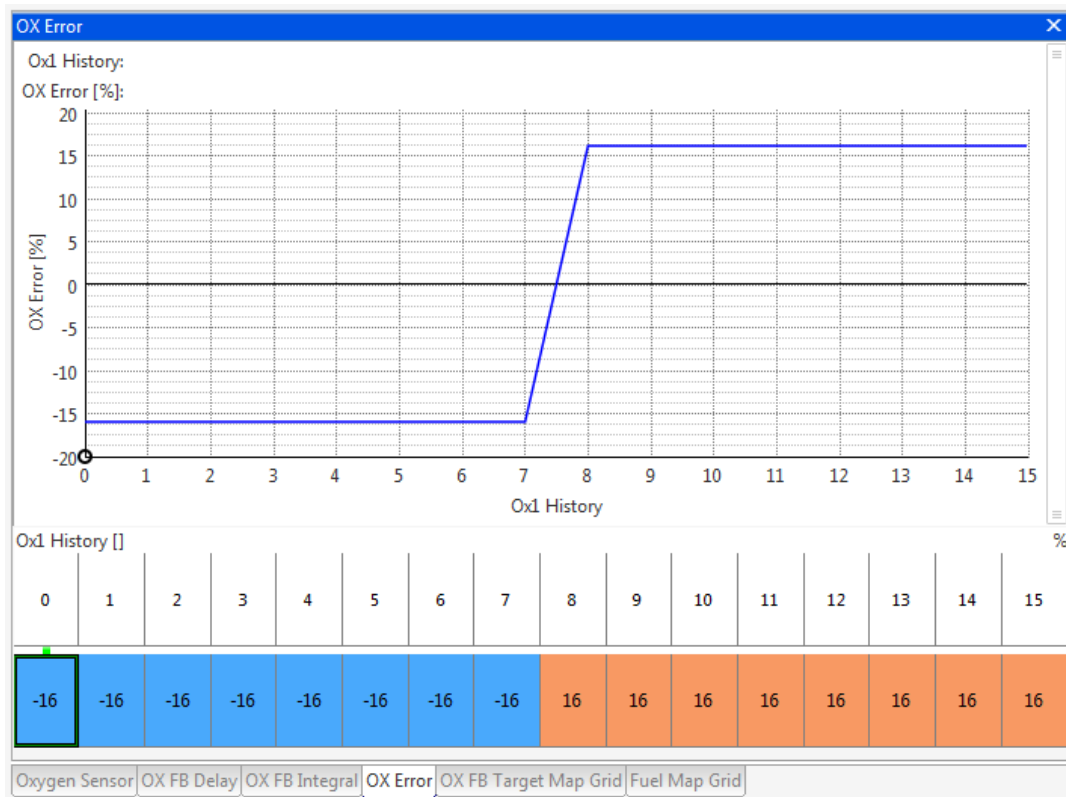

OX FB Integral Table input the following values.

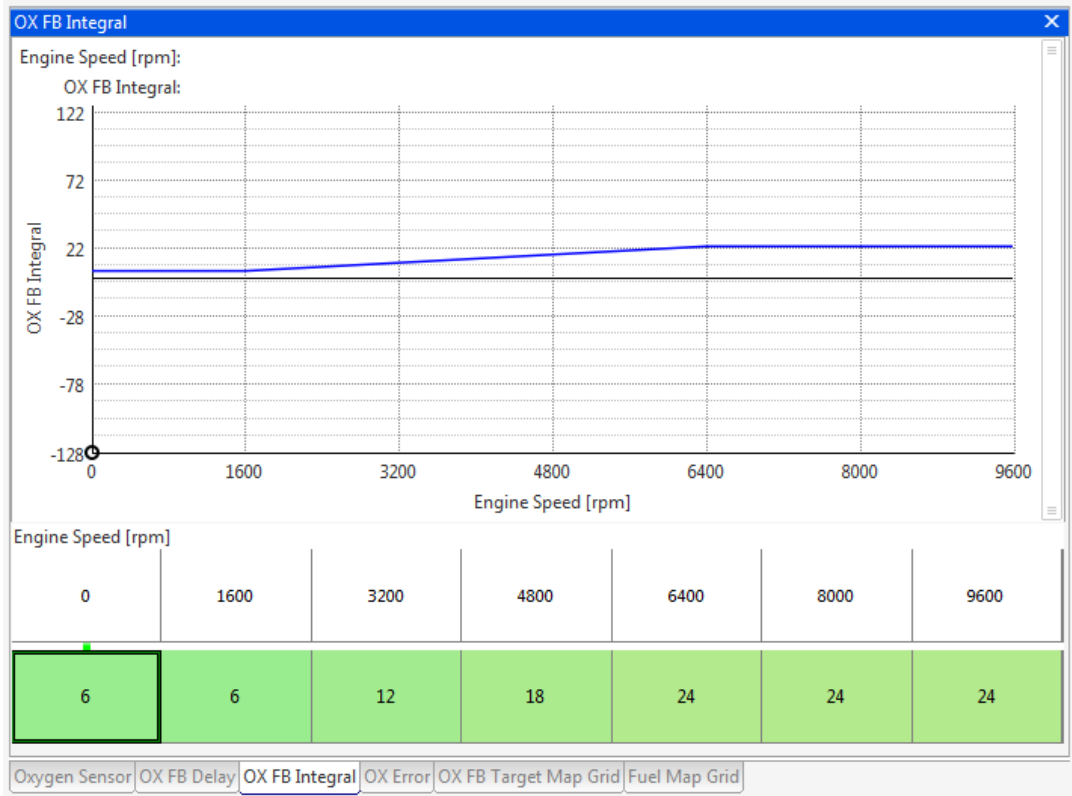

Oxygen Sensor Table input the following values. This shows that at a raw value of below 32, the engine is lean, and at a raw value of above 32 the engine is rich.

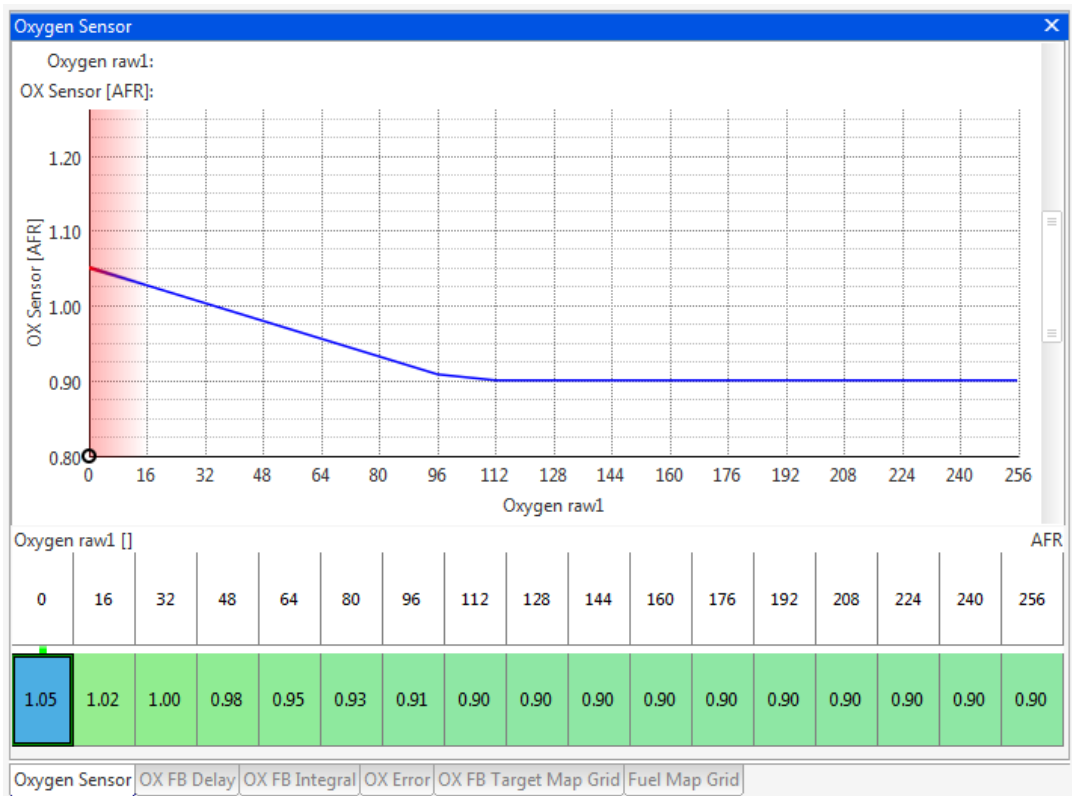

The **Lambda Target Map** shows the target lambda value for all engine speed and load conditions. In the case of narrowband oxygen feedback the whole table should be set to a value of 1.

The oxygen sensor takes a few seconds to warm up after startup as can be seen by its gradual increase from 1 on the **oxygen raw** parameter. Before the sensor is warm we wish to ignore its

value as it will trigger fuelling changes that are not needed. The delay after engine start before starting oxygen feedback is set in the **OX FB Delay Table**.

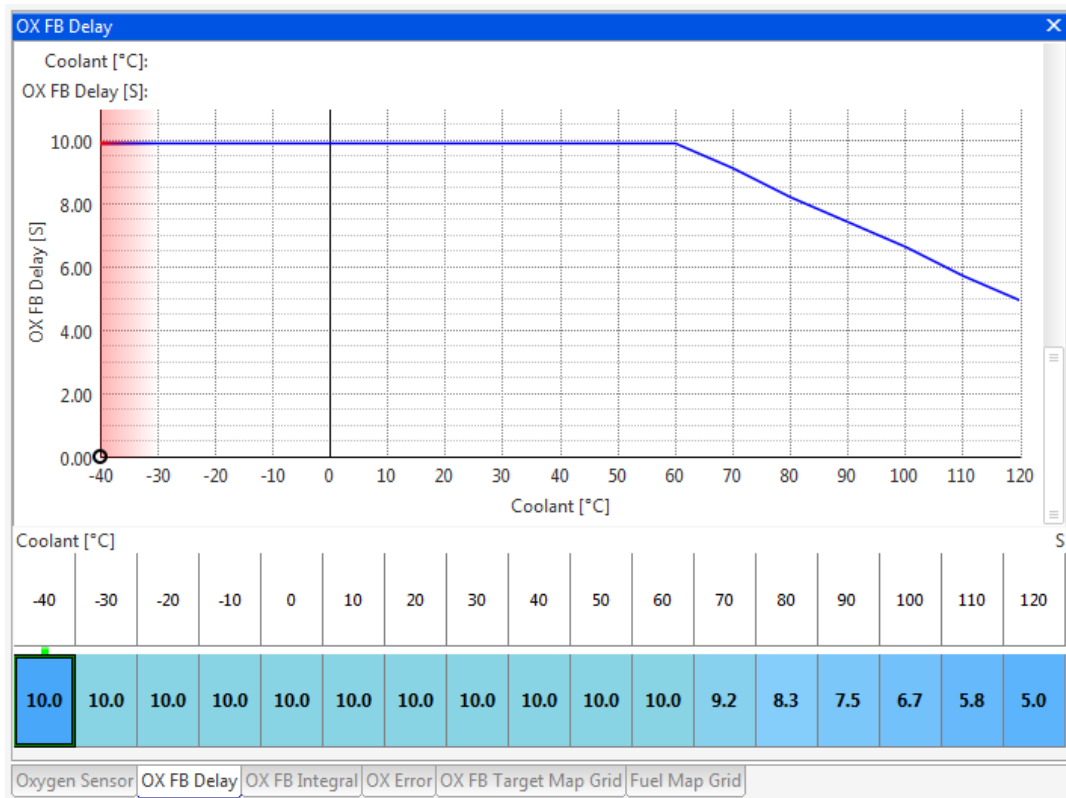

15.2 Wideband

When mapping an engine on a rolling road or engine dyno it is normal to use a wideband lambda reader that is totally separate to the ECU. However, some tuners prefer to see the lambda value on the mapping software too for easier reference or for datalogging purposes.

The lambda reader should have a 0-5V output available, and the lambda reader’s manuals should give the lambda value for each voltage. The ECU scales the incoming voltage of 0-5V as 0-256 in the **OX sensor table**. Enter the relevant lambda values into this table, then the lambda can be constantly monitored by parameter **lambda1**. The output from the lambda reader is usually a straight line relationship, so just the 0 (0V) value and the 256 (5V) value can be entered, then the values in-between calculated by MAP4000 (see the software manual for how to calculate on tables).

Ensure that the lambda feedback is OFF when the wideband input is being used for logging by setting **OX FB rate = 0**.

16 Cooling Fans

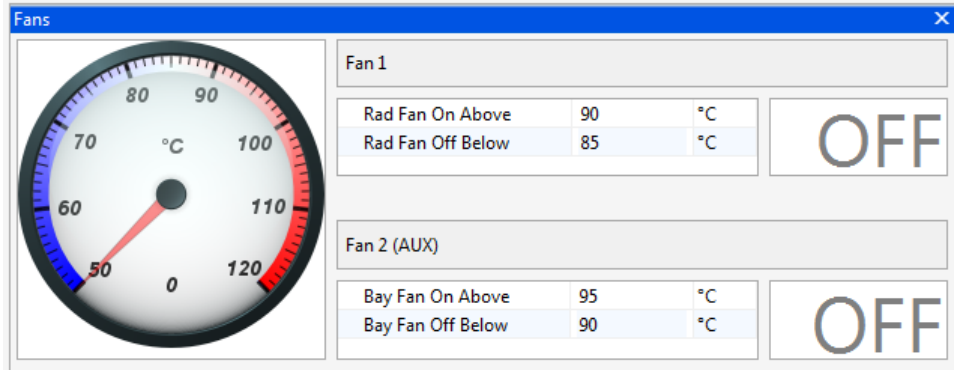

The ECU has two software outputs switchable on coolant temperature values. These would normally be used for cooling fans. The two outputs may be set to two different fans or set at different temperatures for twin speed fans.

Rad Fan On Above
Rad Fan Off Below

temperature at which the rad fan output is on
 temperature at which the rad fan output is off. Set a few degrees lower than Rad Fan On to allow hysteresis

Bay Fan On Above
Bay Fan Off Below

bay fan on at this temperature
 bay fan off at this temperature. Set to a few degrees below Bay Fan On to allow hysteresis

17 Knock Control

Engines make mechanical noise that varies dependent on engine speed. The **Knock Ambient Noise Table** describes this normal background engine noise when running out of knock. The parameter **KNKRAW** shows the current noise measured by the knock sensor. Logging the parameter **KNKRAW** on a full load engine run whilst using a safe ignition map allows you to draw the table of normal noise.

When **KNKRAW** exceeds the **Knock Ambient Noise table** values, the engine is assumed to be in knock. The level of noise above the normal noise is shown by the parameter **Knock**.

When knock is discovered, the ECU needs to react by retarding the ignition to stop knock, and increase the fuelling to cool the cylinder.

The **Knock** value causes an ignition retard (**Knk Ign Retard**) and an increase in fuel (**Knk Fuel Increase**) proportional to the Knock level. The ECU will make these changes to the timing and fuelling every 4ms until knock has stopped. The extra fuel and the ignition retard are capped to a maximum regardless of the calculated values by **Knk Fuel max** and **Knk Ign Retard max**.

After knock has stopped, the fuelling and ignition values need to be returned to normal. The rate is set by **Knk Restore Rate** (engine revolutions) and then **Knk Fuel Restore** (% fuel per rate) and **Knk Ign Restore** (degrees ignition timing per rate).

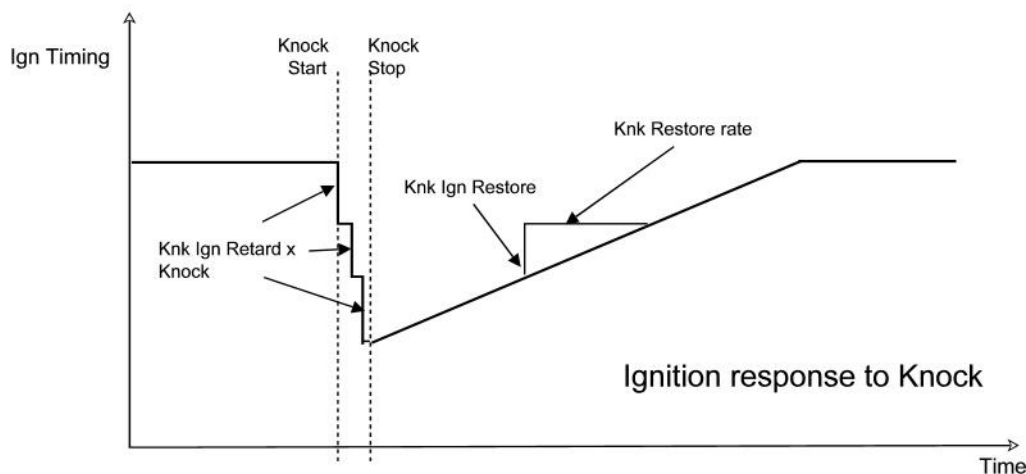
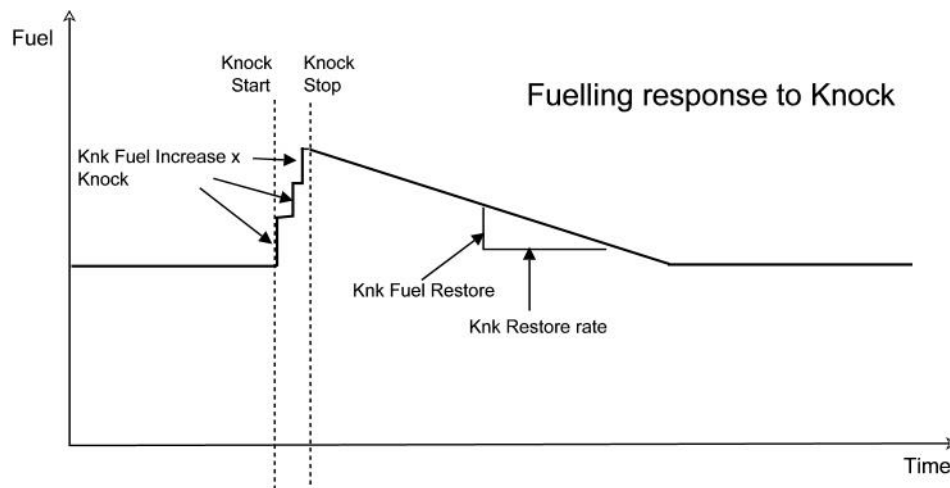

18 Full Throttle Gearshift

FTG Options		
FTG min RPM	0.0	rpm
FTG Retard Rate	0.00	°
FTG Retard Max	0.00	°
FTG Time Max	0.00	mS
FTG Restore Rate	0.00	°

The full throttle gearshift is a switched ignition retard function. When the input for this function is satisfied (normally by a physical input switch on the clutch pedal or gearstick), the ECU retards the ignition at a rate, **FTG Retard Rate**, up to a maximum retard, **FTG Retard Max** (The maximum retard is relative to the current map value, not absolute with a maximum absolute position of 30ATDC). When the input switch changes to **OFF**, the ignition retard will be returned at a rate, **FTG Restore Rate**, until the normal ignition timing is reached. If the input does not go to **OFF**, the timing will be returned after a time set by **FTG Time max**. The retard rate and restore rate are degrees per 4ms. The option **FTG min RPM** is the minimum engine RPM at which a full throttle gearshift retard can be performed. This prevents the engine RPM from dipping when depressing the clutch whilst stationary.

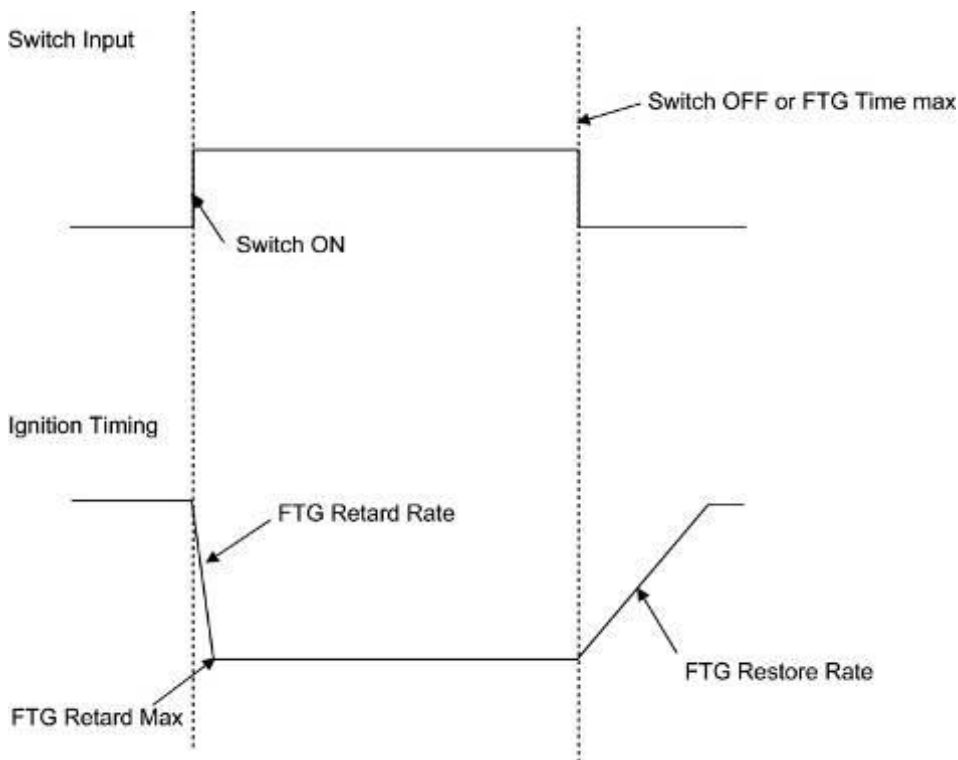

Gearshifts using the clutch

When the clutch is used for gearshifts, the input for the FTG will be a switch on the clutch. In this situation **FTG Time Max** does not want to be used and so is set to 1000, meaning the shift is ended when the switch is turned off.

FTG Options		
FTG min RPM	3000.0	rpm
FTG Retard Rate	89.65	°
FTG Retard Max	89.65	°
FTG Time Max	999.42	mS
FTG Restore Rate	4.92	°

Tuning the FTG is simply adjusting the **FTG Restore Rate** for best feel. A higher value restores the power at a faster rate meaning you get back to full power quickly but you can get a shock through the drivetrain. A lower value restores the power at a slower rate so reduces shocks but too low can waste time where you could be at full power.

Gearshifts without the clutch (sequential gearboxes)

When no clutch is used, the input for the FTG will be a switch on the gear lever. Typically, the gearbox will be in gear when the lever is pulled to full travel and can then take drive before the lever is released. Therefore, the switch will not be released so we cannot use the switch going off as the end point of the shift; we must use a timer.

FTG Options		
FTG min RPM	3000.0	rpm
FTG Retard Rate	89.65	°
FTG Retard Max	89.65	°
FTG Time Max	151.55	mS
FTG Restore Rate	4.92	°

Tuning the FTG involves tuning the length of FTG and the rate of the power restore at the end of the FTG. As there is no feedback to the ECU of whether the gearbox is in gear, the **FTG Time** must be set to the longest typical gearshift. Start tuning using a large value at first. Restoring the power is controlled by **FTG Restore Rate** which is adjusted for best feel. A higher value restores the power at a faster rate meaning you get back to full power quickly but you can get a shock through the drivetrain. A lower value restores the power at a slower rate so reduces shocks but too low can waste time where you could be at full power.

Paddleshift systems

Paddleshift systems will normally have an output that signals to the ECU when it needs to cut power. The system will give us both the start and finish of the FTG. In this situation **FTG Time Max** does not want to be used and so is set to 1000.

FTG Options		
FTG min RPM	0.0	rpm
FTG Retard Rate	89.65	°
FTG Retard Max	89.65	°
FTG Time Max	999.42	mS
FTG Restore Rate	4.92	°

Tuning the FTG is simply adjusting the **FTG Restore Rate** for best feel. A higher value restores the power at a faster rate meaning you get back to full power quickly but you can get a shock through the drivetrain. A lower value restores the power at a slower rate so reduces shocks but too low can waste time where you could be at full power.

19 Staged Injectors

The fuel injectors may be assigned as primary or secondary injectors. This feature allows two banks of injectors to be fitted to each inlet.

19.1 Twin Injectors

If using two injectors per cylinder to allow greater fuel flow, typically on high boost turbo engines, the ECU can automatically assign pulsewidth greater than the user defined **Pri Inj Duty Max** to the second set of injectors.

Options		
Primary Size %	99.61	%
Pri Inj Duty Max	80.08	%
Sec Inj Min Pulse	500	µS

Pri Inj Duty Max

when using double injectors, this is the maximum duty cycle the primary injectors will reach before extra pulsewidth is sent to secondary injectors hysteresis for the automatic staged injectors as injectors will not react to very small pulse widths. This is the minimum pulse width that will be sent to the secondary injectors.

Sec Inj Min Pulse

Primary Size %

If using two different sized injectors, this option must be used to allow for this. $\text{Primary Size \%} = (\text{Primary flowrate} / \text{Secondary flowrate}) \times 100$.

19.2 Staged Injectors

If using two sets of injectors arranged upper and lower banks where the upper bank is used for increased power at high rpm, the **Fuel Difference table** allows you to assign different percentage of the fuel pulsewidth to each bank.

The **Fuel Difference table** describes the percentage of the mapped pulse width at any given load and speed to be sent to the secondary injectors. The remaining pulsewidth will be sent to the primary injectors. eg if the map reads 20, then 20% of the pulsewidth will go to the secondary injectors, and 80% to the primary.

This table is only used when the **Fuel Diff Input** is satisfied. This can be always satisfied by setting an input of **Switch Always ON**.

Inputs	
Fuel Diff Input	Switch is Always ON

The values set in the twin injector options still apply when using the **Fuel Diff table**.

20 VTEC Cam Control

Options		
VTEC On Above rpm	5000	rpm
VTEC Off Below rpm	4800	rpm
VTEC On Above TPS	10.16	%
VTEC Off Below TPS	7.81	%
VTEC On Above Load	0.00	kPa
VTEC Off Below Load	0.00	kPa
VTEC Fuel Trim	0.00	%
VTEC Ign Trim	0.00	°

The simple on/off VTEC control is switchable on engine RPM, throttle position, and engine load with hysteresis provided by separate on and off points. In the VTEC condition there is also a fuel and ignition trim. When using TPS as load, set the Load options both to 0.

Some engine benefit from the cams being switched back to the typically low speed position at high engine speeds. If this is the case then the Alt Function can be utilised instead of the VTEC function.

21 VVC Cam Control

VVC (also known as many other names such as i-VTEC, VANOS etc) is constantly variable cam control. Normal VTEC will switch from one cam position to another whereas VVC allows any cam position within limits. The cam position varies with engine speed. Each manufacturer has a slightly different way of triggering this cam movement, so please contact Omex for advice on whether a particular engine has been run with the Omex VVC control.

22 Turbo Boost Control

Boost pressure is regulated by the turbo wastegate which is opened at a boost pressure set by the actuator. To increase the boost pressure at which the wastegate is opened, the actuator needs to see a lower pressure than actually exists in the manifold. The ECU is able to control a solenoid to lower the pressure that the actuator sees, therefore increasing the boost pressure at which it opens the wastegate. The ECU can therefore never reduce the maximum boost to below that of the actuator setting, it can only be increased.

As the solenoid is a PWM device, the map describes the duty cycle of the solenoid against engine load (boost pressure) and engine speed. A value of zero would not activate the solenoid, and a value of 100 would have the solenoid open fully.

Normally, the engine would be first mapped without the boost control activated. The fuel and ignition values can then be guessed for the load sites not yet reached. The **Wastegate Duty map** is used to increase the boost to the required level, then these sites can be fully mapped.

The **Wastegate Duty map** is engine load (boost pressure) vs engine speed. At the engine speeds where extra boost pressure is desired, the solenoid may be opened just before the boost reaches the maximum permitted by the actuator to allow the engine to boost to the desired pressure. At boost pressures above the desired pressure, the solenoid should be closed again to prevent overboost.

23 Anti-lag

Anti-lag keeps the boost pressure high and the turbocharger spinning by keeping the gas flow high, but maintains drivability by controlling the torque. The gas flow can be achieved by jacking the throttle with a solenoid, air bypass valves, or if a low level of anti-lag is used, often by opening the idle motor. To control torque, the ECU retards the ignition and cuts fuel and sparks.

In reducing engine torque, anti-lag produces very high exhaust gas temperatures which can cause damage to the manifold and turbo. If using anti-lag, monitor exhaust gas temperature very closely when setting-up and consult your turbo manufacturer for guidance on maximum temperatures.

When the antilag input is satisfied, three tables are used to maintain engine speed based on throttle position – an ignition retard table, an ignition cut table, and a fuel cut table. Once the engine speed exceeds the speed in the table, the relevant soft cut option is invoked. If the speed is exceeded by 50rpm the hard cut option is added to increase the effect. The first torque reducer to use is the ignition retard, then the ignition cut, and finally if required, the fuel cut.

The **Ign Cut RPM table** and **Fuel Cut RPM table** found on the Anti-lag tab are copies of those found on the **Rev Limiters** tab.

If using the idle motor to give anti-lag airflow, then the option **ALS Idle** is the percentage duty cycle added to the idle motor to open it when the **ALS input** is satisfied. This would often be 100%.

ALS Air Max is the air temperature above which ALS turns off and the ECU shuts its controlled valves.

ALS Off Road Speed – If the ECU has a road speed input, this option allows the anti-lag to be deactivated above a set road speed. This allows the anti-lag to be used as a launch control for engines that require boost at low RPM for launch.

ALS Active Time is the longest time the ECU will stay in anti-lag mode before turning off to prevent excessive exhaust gas temperatures if coasting downhill. **ALS Inhibit Time** is the minimum time after turning anti-lag off that it can turn on again.

It is possible on some engines to create more boost in anti-lag mode by increasing the fuel. This is done using the **ALS Fuel Trim table**.

24 Alt Function

The Alt function is a possible fuel trim, ignition trim, and physical switch output based upon an entry condition set by the user. The entry condition can be a physical input switch, engine speed, engine load, throttle position, or a combination of these. The throttle entry condition has separate on/off values to allow hysteresis. The load and RPM entry conditions have a minimum and maximum between which the function is ON. For the trims to be available simply on a switch, then set the rpm, TPS, and load on/off conditions to conditions the engine is always under. For the trims to be active under certain engine conditions without any switch input then set **Alt Function Input** to **Switch is Always ON**.

Example applications

Nitrous ignition retard

An input to the ECU can be made when the nitrous circuit is complete on one of the AUX IN pins. The auxiliary input should be set for the Alt Function to AUX *n* IN (*n* dependent on the input used) as shown in the appropriate section of this manual. The ignition retard is then required regardless of throttle position, engine speed etc, so the values are set as shown below;

Function Entry Conditions			Function Trims		
Alt rpm min	0	rpm	Alt Spark Trim	-3.16	°
Alt rpm max	25500	rpm	Alt Fuel Trim	0.00	%
Alt Load min	0.00	kPa			
Alt Load max	99.61	kPa			
Alt Throttle On	0.00	%			
Alt Throttle Off	0.00	%			

VTEC control

Normally, the dedicated VTEC function would be used to control VTEC cams, but some engines benefit from having the cam to be moved back to the low position at high engine speeds. In this case, the Alt function must be used. A switch input is not required as the VTEC function is required all of the time, so the auxiliary input should be set to **Switch is always ON** as shown in the appropriate section of this manual. An output is required based on this function so the **Alt out** option should be set to one of the auxiliary outputs. The below shows the VTEC used in its most simple form with just on/off points based on engine speed (on between 3000 and 6500rpm), irrespective of throttle position and load;

Function Entry Conditions		
Alt rpm min	3000	rpm
Alt rpm max	6500	rpm
Alt Load min	0.00	kPa
Alt Load max	99.61	kPa
Alt Throttle On	0.00	%
Alt Throttle Off	0.00	%

25 User1

The User1 table uses a raw source (scaled to 0-255) for the upper (input) axis of the table to drive a PWM output, the duty cycle of which is defined on the lower axis of the table.

The raw input is selected by option **User1 source**. Useful selectable sources are;

- Air temperature
- Baro pressure
- Battery voltage
- Coolant temperature
- Engine Speed
- Injector duty
- Knock
- Lambda
- MAP
- Throttle position

The PWM output number used is defined by the option **User1 PWM out**.

26 Internal Data Logging

The internal data logging memory is 512k and varies in time duration dependant upon the logging sample rate. There are 7 fast channels featuring recording rates of up to 250 times per second, and 8 slow channels, the log rate is displayed for the fast and slow channels separately, as well as the time duration that the log rate will allow.

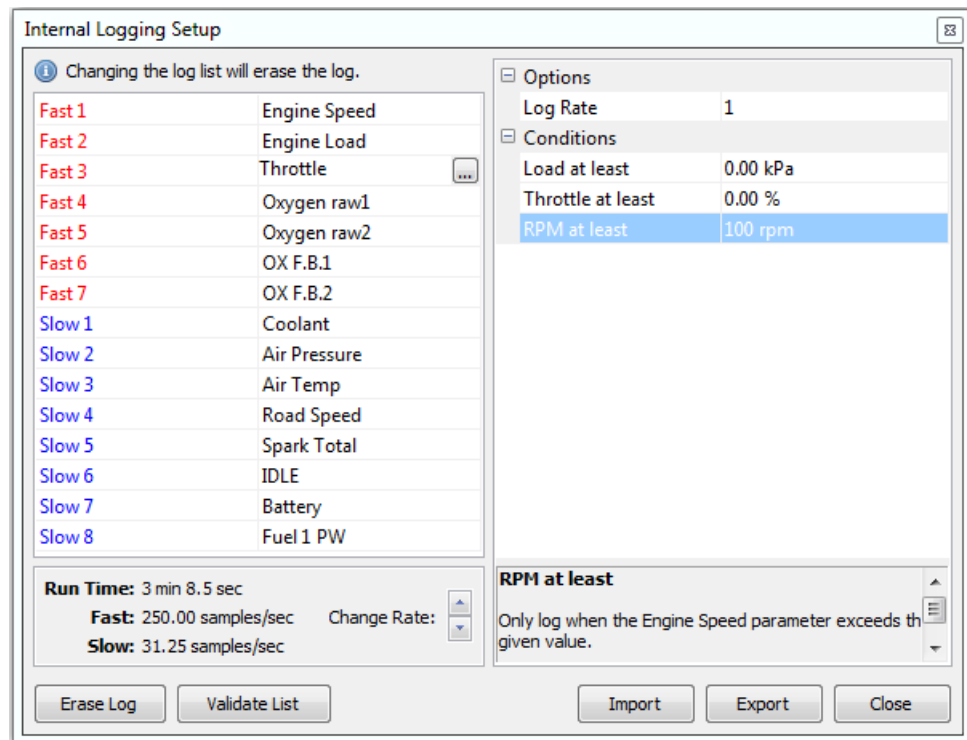

Logging can be triggered to start and stop dependent on engine conditions;

Load at least

The engine load must exceed this value to activate logging.

Throttle at least

The throttle position must exceed this value to activate logging.

RPM at least

The engine rpm must exceed this value to activate logging.

Rate

This function allows the user to change the rate at which the selected channels are recorded. The total logging time based on the number and rate of parameters logged will also be displayed here.

Saving the Datalog

When a log is completed go to **Logging | Download Internal Log**. You will then be prompted for a file name and location.

You will then be prompted for notes to be entered. Enter any specific information that pertains to the datalog. ie added 5% fuel, etc. After the information has been entered, click on the close icon "x" box. All notes are then saved with the log file for later viewing using the DATA2000 software.

27 Ignition Dwell Control

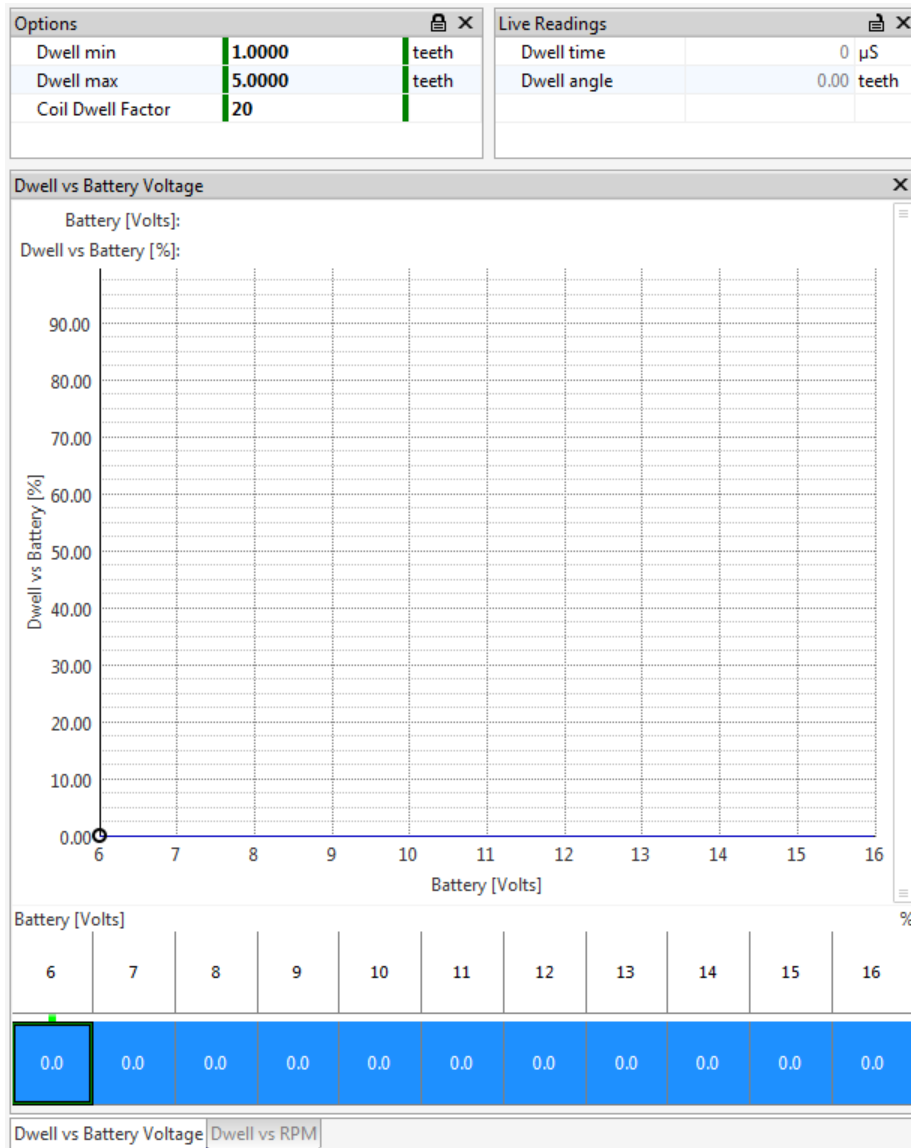

The coil dwell time is set by option **Coil Dwell Factor**. This is a unitless value typically 20 - 25 for a DIS coil pack. Charge times can be varied with respect to battery voltage and engine speed using the **Dwell vs Battery table** and **Dwell vs Speed table**. Setting these table values to 100% gives a constant dwell time.

The options **Dwell max** and **Dwell min** are the limits of dwell time regardless of calculated values from the tables and coil factor option. These limits are measured in internal units. Contact Omex if you want to change these values.

When running the engine, the current dwell time can be monitored using parameter **Dwell Time**.

Calibrating Dwell Time

A startup calibration from Omex will have typical values for charge time alterations against battery voltage and engine speed so you will normally only need to adjust the **Coil Factor**. You should use the lowest value that still makes the greatest torque output from the engine.

28 Security

Do not use the password features unless you have a particular requirement for it. If you password-protect an ECU and lose the password, Omex CANNOT retrieve the calibration for you. THERE IS NO 'MASTER' PASSWORD.

The ECU has security features that allow calibrations to be password protected. All Omex calibrations are sent with the password cleared to allow all users access to the ECU. If you are using security, clear the password at the beginning of a mapping session and set at the end. If setting a password, keep notes of it and make sure that you have a copy of the last calibration in the ECU.

Setting a password

When connect to an ECU, a password may be set. To set a password;

- Connect to the ECU
- Select **ECU | Security | Set Password...**
- A dialog box appears prompting for a password. The password may be any alphanumeric 6 character password.



- Ensure that 'Set as Default Password' is NOT checked.
- Enter a password and click **OK**.

Clearing a password

Once connected to a password protected ECU, the password may be cleared. Clearing the password removes the security such that any PC can connect to this ECU.

To clear the password;

- Connect to the ECU
- Select **ECU | Security | Clear Password...**

Clearing a protected ECU

If using an ECU where the password is unknown it is possible to use the ECU. The information in the ECU will be lost so the original calibration will never be accessed, and the ECU will instead be filled with random numbers.

- **ECU | Connect**
- A dialog box appears prompting for a password.

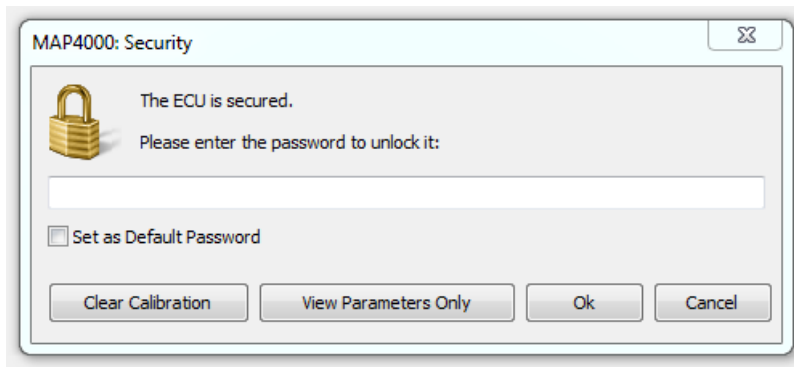

- As the password is unknown click **Clear Calibration**.
- A dialog box appears asking if you wish to erase the calibration to allow access. Click **Yes**.

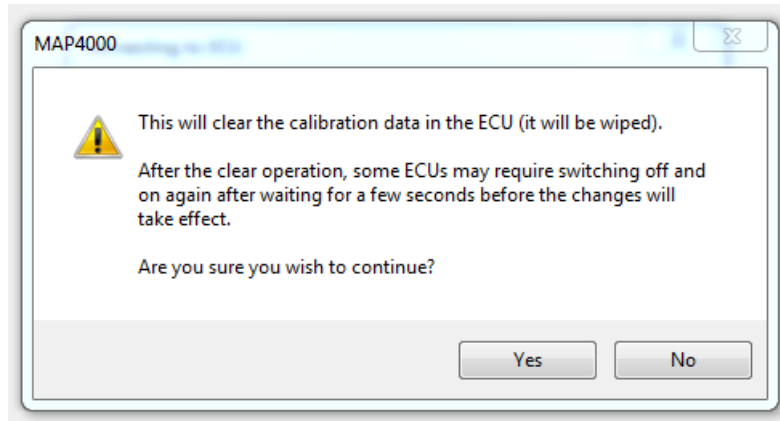

- The PC will clear the ECU.
- **ECU | Send new calibration**. Select your new start-up calibration.
- Once the calibration has sent, cycle ignition off / on.

29 Wiring

29.1 Semi Assembled Loom Construction

The engine bay is a harsh environment for wiring harnesses with oil, water, solvents, high temperatures, high vibration, and high electrical noise. The semi-assembled wiring harness is made from automotive grade cable and the shielded cables are already made-up at the ECU connector to prevent electrical noise problems.

The following should be noted when constructing the loom;

- The ECU should be mounted away from sources of extreme heat (such as exhaust), and away from direct water spray.
- The connector terminals should be either crimped with the correct tool or crimped and soldered.
- The looming material holding the wires in the loom should totally cover the wires to prevent chaffing of the wire insulation.
- If the loom is to go through panels, grommets should be used.
- The loom should be tied to mounting points using cable ties or p-clips to limit the additional stresses of the loom moving.

29.2 ECU Connector Pins

It is occasionally necessary whilst fault finding to trace through your wiring harness to check continuity. The following are the pin-outs for the ECU plug as found on the end of the wiring harness. Where there are two colours, the first is the main colour and the second is the tracer eg

Yellow violet – yellow with violet tracer

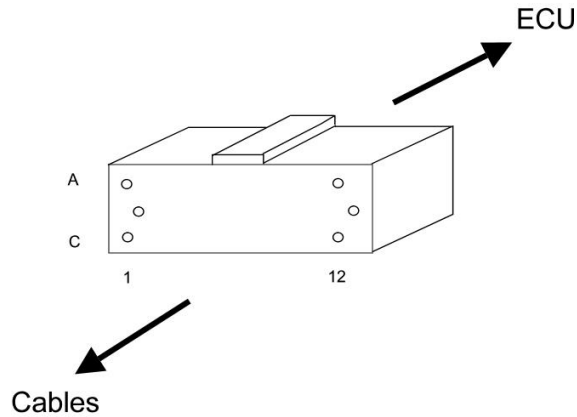

number	colour code	output name
1A	Yellow black	IGN1
2A	Yellow violet	IGN6
3A	Brown pink	FUEL8
4A	Red	Battery power
5A	Black	Power ground 1
6A	Grey	Sensor ground
7A	Black screened red	Crank sensor
8A		Timing ground
9A	White violet	Coolant temperature sensor
10A	White yellow	MAP2
11A	Red screened red	Cam Sensor
12A	Yellow grey	IGN2
1B	Yellow orange	IGN4
2B	Yellow green	IGN5
3B	Brown violet	FUEL6
4B	Brown black	FUEL1
5B	Brown green	FUEL5
6B	Blue white	MAP1
7B	Black	Power ground 2
8B	Brown grey	FUEL7
9B	White green	Air temperature sensor
10B	Blue	Knock sensor
11B	White orange	Oxygen sensor 2
12B	Yellow red	IGN3
1C	Blue grey	HIGHSIDE2
2C	Brown orange	FUEL4
3C	Brown yellow	FUEL2
4C		
5C	Blue black	HIGHSIDE1
6C	Brown red	FUEL3
7C	White red	Oxygen sensor 1
8C	Orange	Throttle position sensor
9C	Pink	5V out
10C	Red Blue	Road speed sensor
11C	White pink	ALT POWER
12C	Blue yellow	Tacho

29.3 Component Pin-outs

Throttle Position Sensors (TPS)			
Omex Part Number	Description	Pins	Omex Wire Colour
OMEM2001	General Purpose	1 Signal (green) 2 +5v (red) 3 Sensor Earth (Black)	Orange Pink Grey
OMEM2005	Jenvey	1 Signal (red) 2 +5v (Green) 3 Sensor Earth (yellow)	Orange Pink Grey

MAP Sensors			
Omex Part Number	Description	Pins	Omex Wire Colour
OMEM2001	1 Bar	1 Signal	Grey Pink
OMEM2002	2 Bar	2 Sensor Earth	
OMEM2003	3 Bar	3 +5v	

Coils			
Omex Part Number	Description	Pins	Omex Wire Colour
Sagem / Valio Coil OMEM3501	4 Cyl DIS	1 Ign 1 2 Ign 2 3 +12v Supply 4 n/f	Switched
Ford Coil OMEM3503	4 Cyl DIS 3 pin	1 Ign 1 2 +12v 3 Ign 2	Switched

Temperature Sensors			
Omex Part Number	Description	Pins	Omex Wire Colour
OMEM2200	Coolant Temp (CTS)	1 Sensor Out 2 Sensor Earth	White / Violet Grey
OMEM2201	Air Temp (ATS)	1 Sensor Out 2 Sensor Earth	White / Green Grey

Crank Position Sensors (CPS)			
Omex Part Number	Description	Pins	Omex Wire Colour
OMEM2401	2 hole mounting	1 Sensor Out 2 Sensor Earth	Black screened red Black screened blue

Oxygen (Lambda) Sensors			
Omex Part Number	Description	Pins	Omex Wire Colour
OMEM2300	4 wire	Sensor Out (Black) Sensor Earth (Grey) Heater (White) Heater (White)	Grey +12v Switched Earth

29.4 Diagrams

The diagrams section shows how various inputs, outputs etc should be wired.

To switch power to the coils, injectors etc based on the fuel pump output from the ECU, typically,

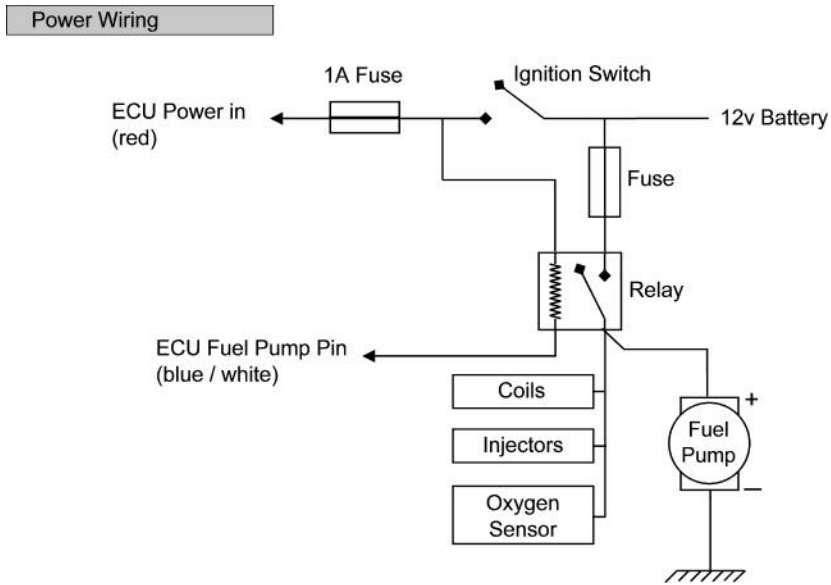

The following diagram shows examples of how injectors should be wired for a 4 cyl engine. Firstly is the case of one injector per output ie sequential fuelling, then two injectors per output ie semi-sequential. When paired, you should ensure that the correct injectors are joined. If standard 4 cyl firing of 1342, then 1+4 should be paired, and 2+3. If the injectors have an impedance of less than 6ohms they require ballast resistors. Each ballast resistor should cover two injectors only.

1 injector per output

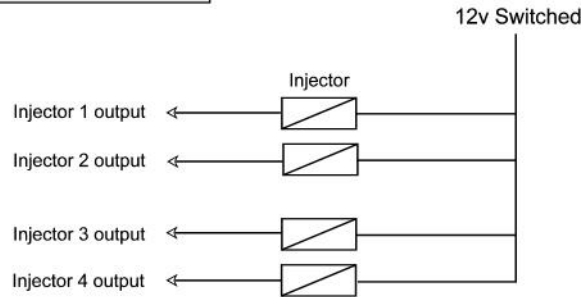

2 injectors per output

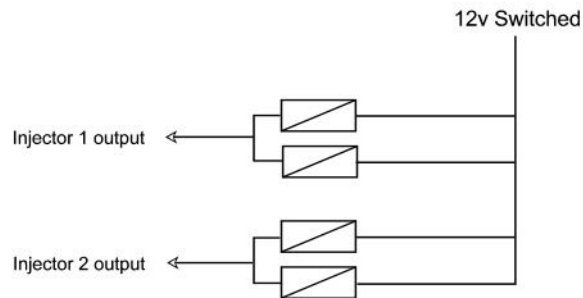

Low impedance injectors

One resistor per output

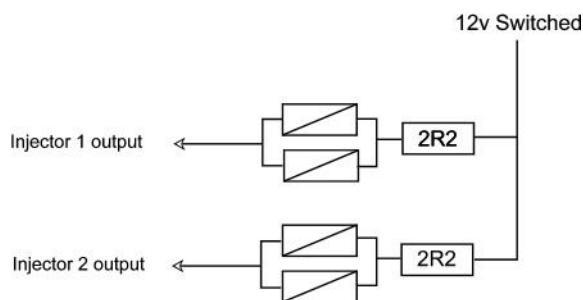
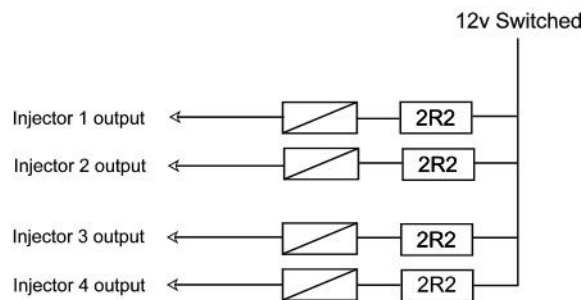

PWM devices driven from the FUEL1-8 outputs require a diode between their output and power.

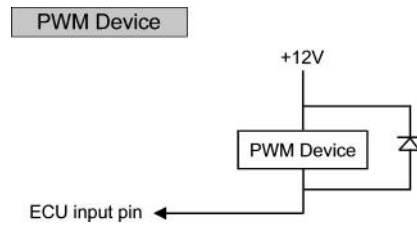

There are two types of input for the ECU, highside and lowside. Most inputs are highside. Contact Omex for advice.

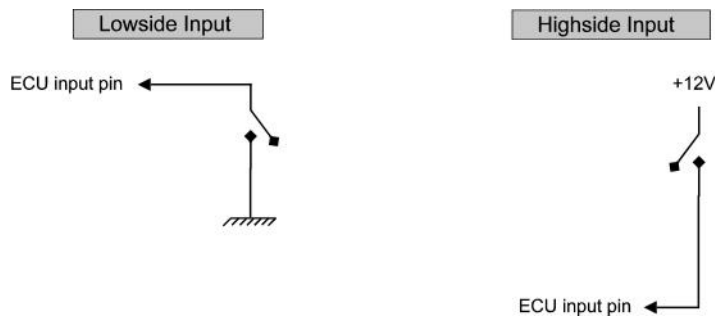

If an input is to be switched at the same time as something physical eg a solenoid for ALS, then the physical input switch can both turn on the solenoid and give an input to the ECU.

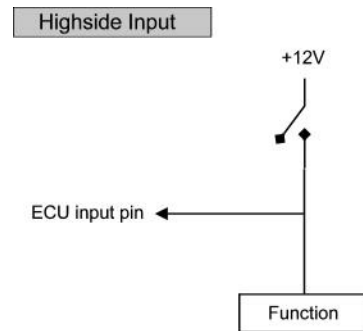

The lowside outputs are unable to directly earth a large current, so they should be used with a relay

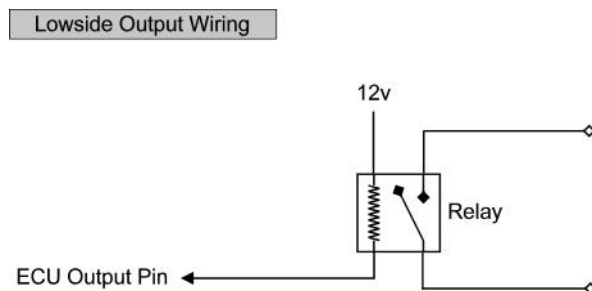

Highside Output Wiring

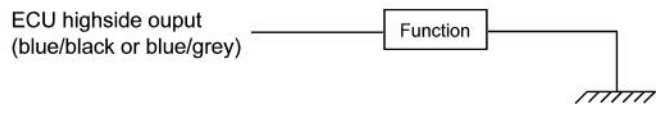

Highside Shiftlight Wiring

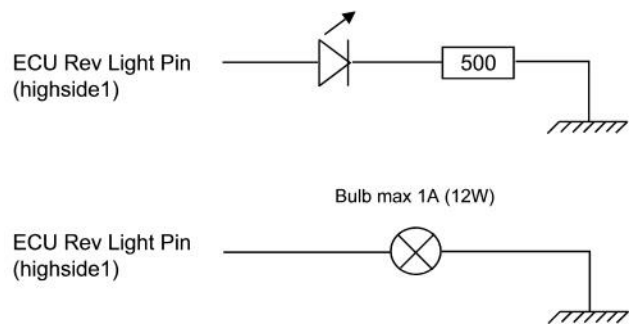

The tacho output if used is a lowside switch so replicates a coil negative pulse.

Tacho Wiring

